

SHEAF

14K

*Sheaffer's*

WRITING INSTRUMENTS

featuring the

*14K* **SNORKEL** *14K*

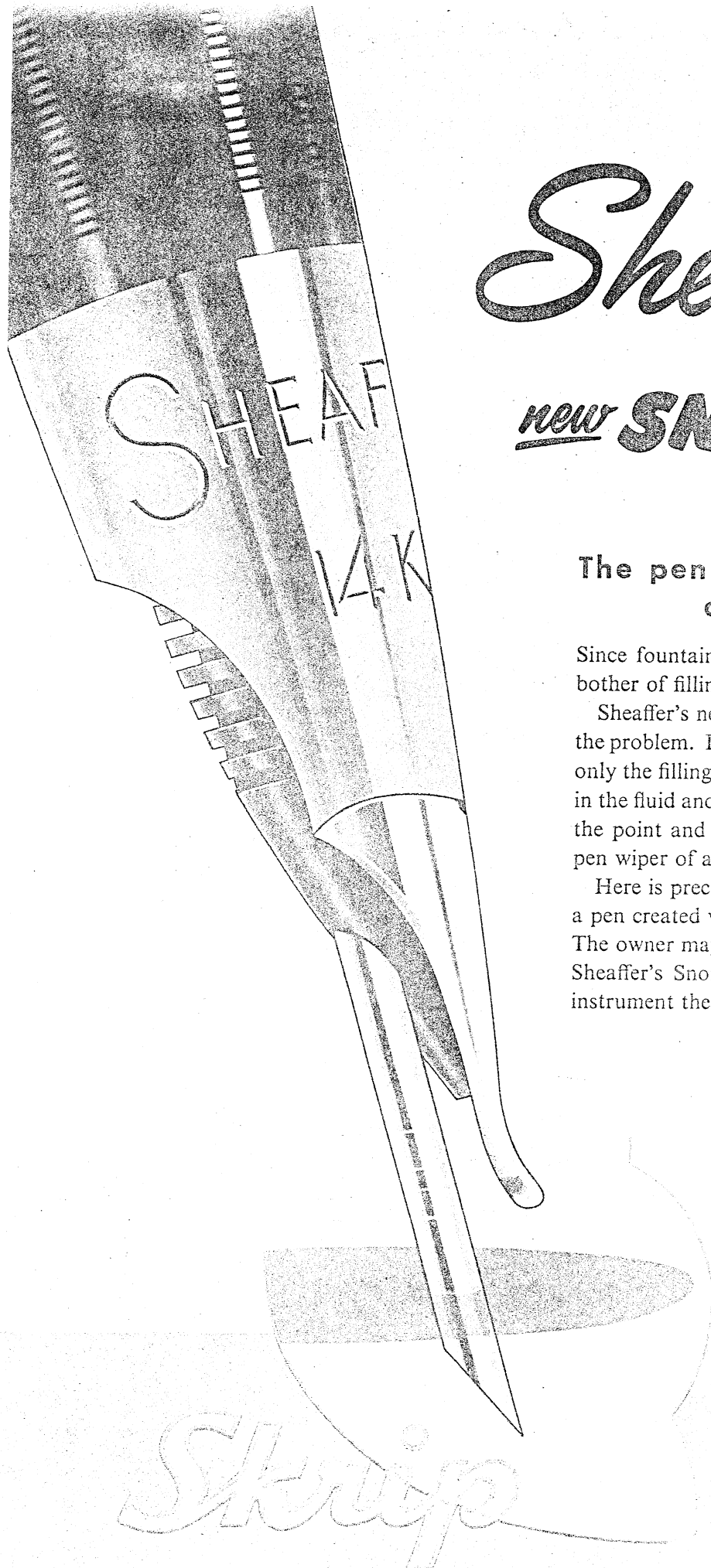

# Sheaffer's

*new* **SNORKEL** pen

The pen that takes the "DUNK"  
out of pen filling

Since fountain pens were first invented, the mess and bother of filling has been a prime objection.

Sheaffer's new Snorkel Pen is the first real answer to the problem. Instead of "dunking" the point and barrel, only the filling tube touches the ink. It extends to draw in the fluid and withdraws when the pen is filled, leaving the point and barrel clean and free of ink. There's no pen wiper of any kind needed.

Here is precision craftsmanship in its highest degree, a pen created with the user's wants and needs in mind. The owner may well be proud in the knowledge that in Sheaffer's Snorkel Pen he possesses the finest writing instrument the world has ever seen.

**SHEAFFER'S**  
WHITE DOT  OF DISTINCTION

Second only to the Snorkel Pen in cleanliness and ease of filling is Sheaffer's new "Tip-Fill" feature. Another example of Sheaffer leadership, it provides progress at low cost, yet is available in no other pens at any price!

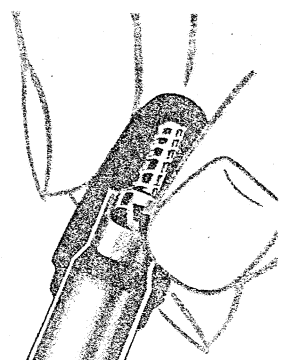

## **SIMPLE**

**to operate as . . .**

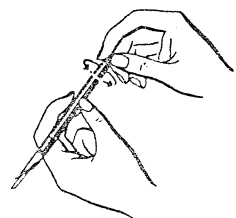

**1.**

Twist—and the filling tube extends beyond the point.



**2.**

Touch plunger down just once. Pen fills on down stroke.

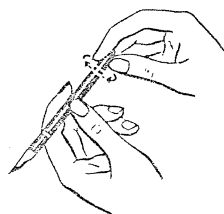

**3.**

Twist—filling tube retracts. No pen wiping is necessary. Ready to write instantly.

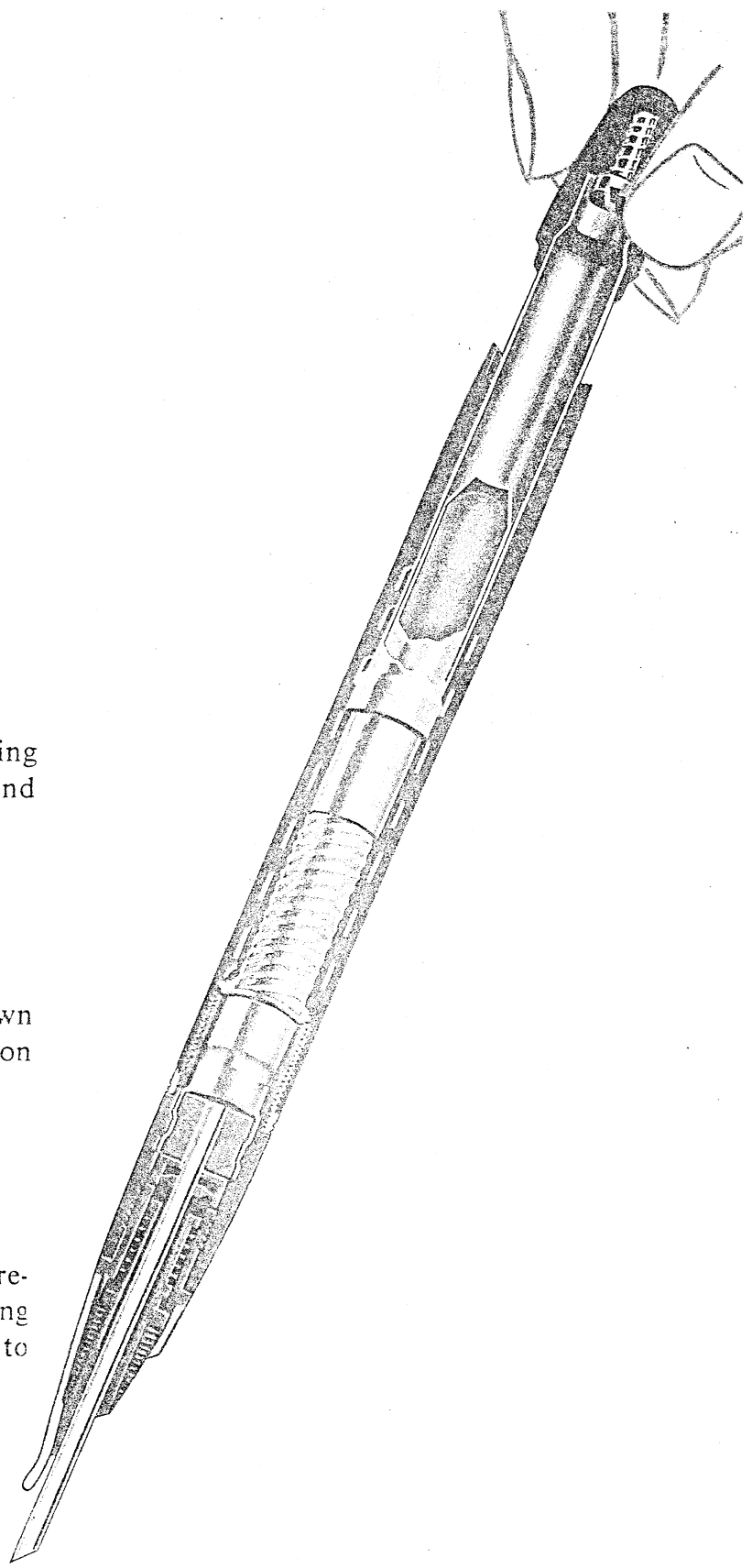

## **PLUS THESE EXCLUSIVE SHEAFFER'S FEATURES**

### **THIN MODEL DESIGN**

Slimmer, trimmer, to rest more comfortably in the hand.

### **HUMIDOR CAP**

Screw-on cap prevents slippage. Keeps point always moist.

### **14K GOLD NIB**

Precious metal ground to 16 individual writing styles.

### **INNERSPRING CLIP**

Self-adjusting. Holds firmly to any fabric, thick or thin.

### **SPIRAL GRIP**

Easier to hold. Reduces writing pressure and fatigue.

### **TOUCHDOWN FILLING**

One downstroke fills completely. No pumping, no priming, no uncertainty.

# Sheaffer's Masterpiece

New **SNORKEL** pen  
with *Lifetime\** Point  
and matching pencil

14K GOLD

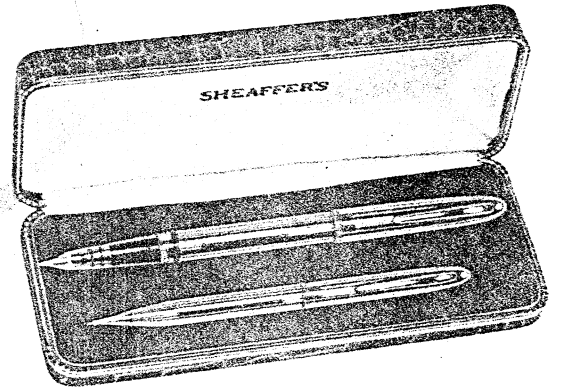
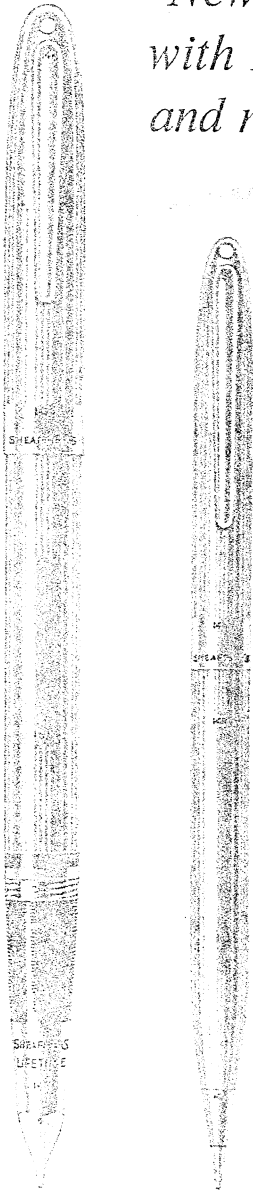

No other writing equipment in the world so justly deserves encasement in genuine 14K gold. Sheaffer's Masterpiece pen with *Lifetime\** point and matching pencil is the most distinctive pen and pencil gift set in the world. It's especially suited for those occasions requiring the finest money can buy.

\*The Lifetime point—unconditionally guaranteed for first user's lifetime without repair charges.





# Sheaffer's for your Autograph

New **SNORKEL** pen, with  
matching ballpoint and pencil

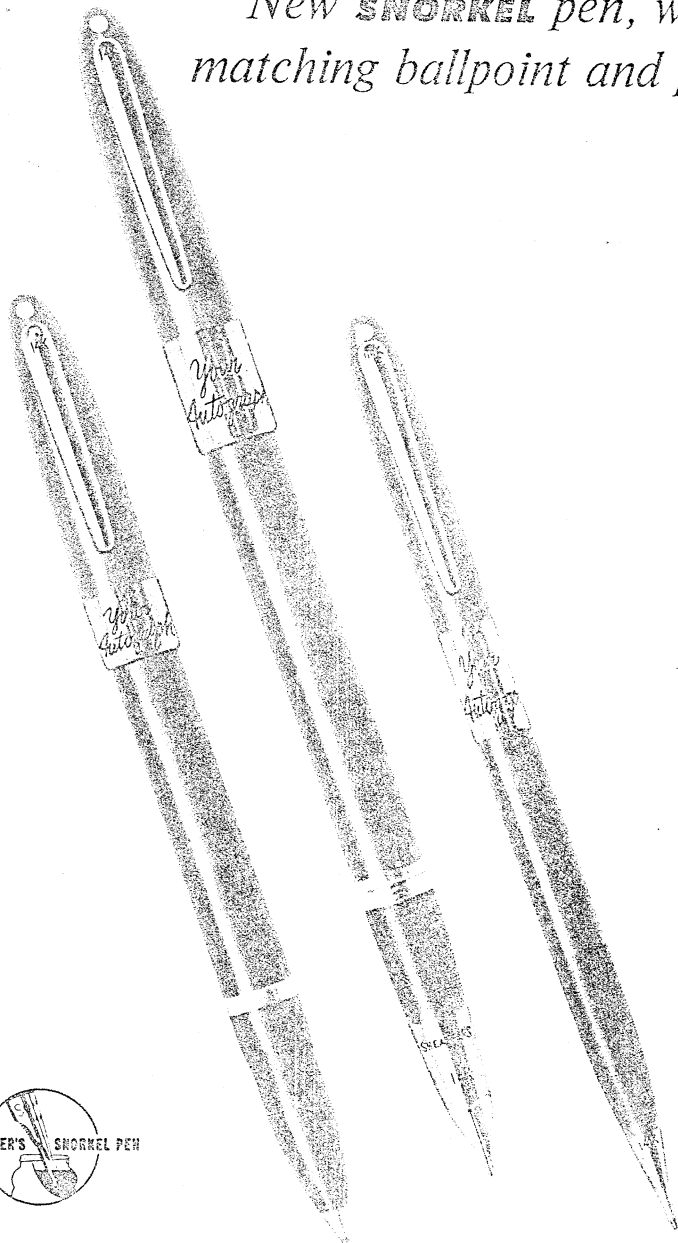

For more than a generation, Sheaffer models for your autograph have been the ultimate in personalized gifts. The user's autograph just as he writes it is hand-engraved, without extra charge, in the wide, genuine 14K gold bands for positive identification. Nothing but 14K gold is used in the clips, pen point and pencil tip to increase its value to the proud owner, year after year.

*Black only.*

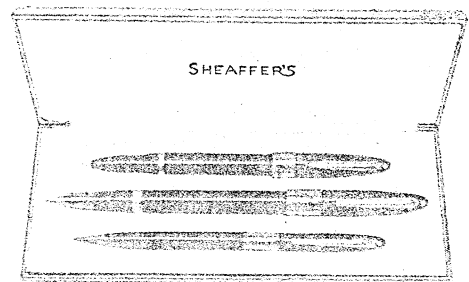



# Sheaffer's Crest

*New SNORKEL pen*

*with matching ballpoint  
and pencil*



The handsomely-rich effects attained by blending the glow of gold with warm colors sets the Crest apart from the commonplace. In its presentation case or in the pocket, the Crest is instantly recognized for superb quality. Points carefully ground in 14K gold.

COLORS: *Black, pastel green, aqua, burgundy, grey.*

# Sheaffer's for your Signature

New **SNORKEL** pen  
with matching ballpoint  
and pencil

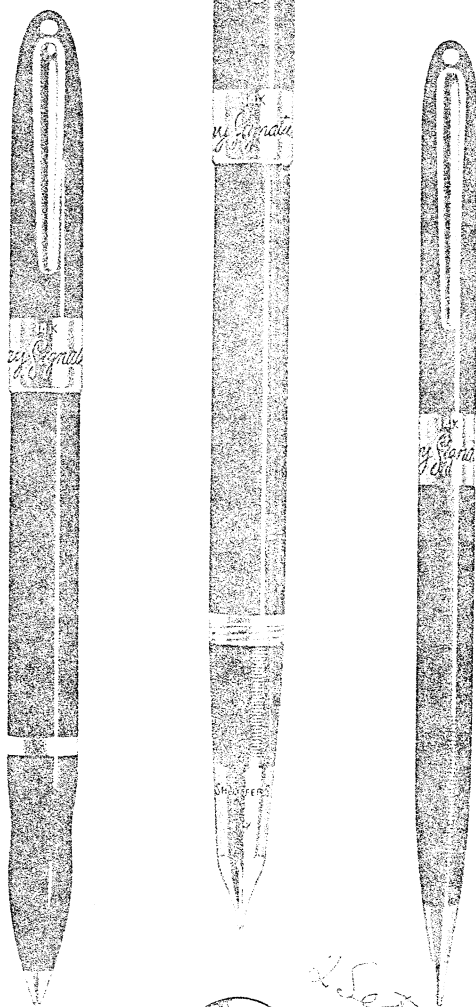

The owner's signature, faithfully reproduced in the 14K gold bands, personalizes this proud possession. As a gift, it offers fadeless proof of thoughtful selection . . . expressly chosen for one person alone. Incomparable performance increases the value of ownership throughout the years. Point of 14K gold. Bands signature-engraved—no extra charge.

COLORS: *Black, pastel green, burgundy.*

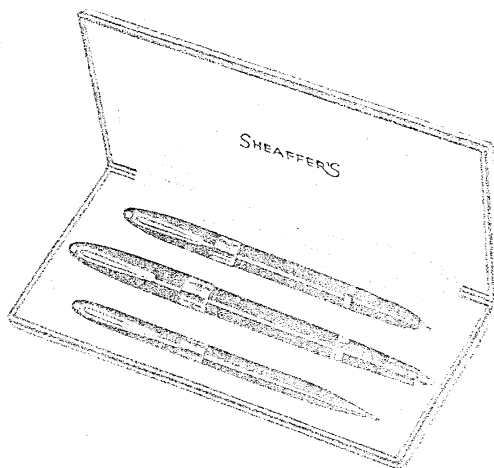

2-





Every line of design and detail bespeaks Sheaffer's famed quality in the Sentinel. Mirror-finished metal caps are accented by gold-filled trim and modern chasing. A soft innerglow adds warmth to the lustrous colored barrels. In combination . . . an overall effect of distinctive quality. Points of 14K gold.

COLORS: *Black, burgundy, pastel green, aqua, grey.*

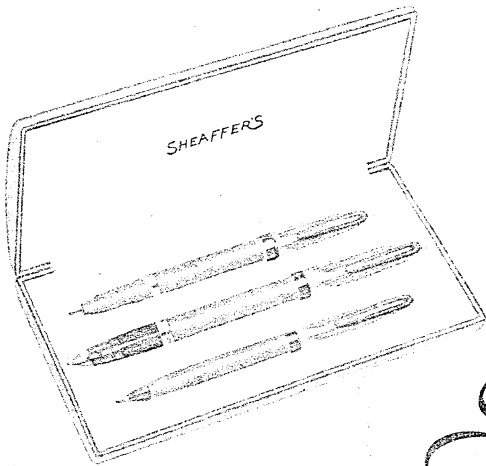
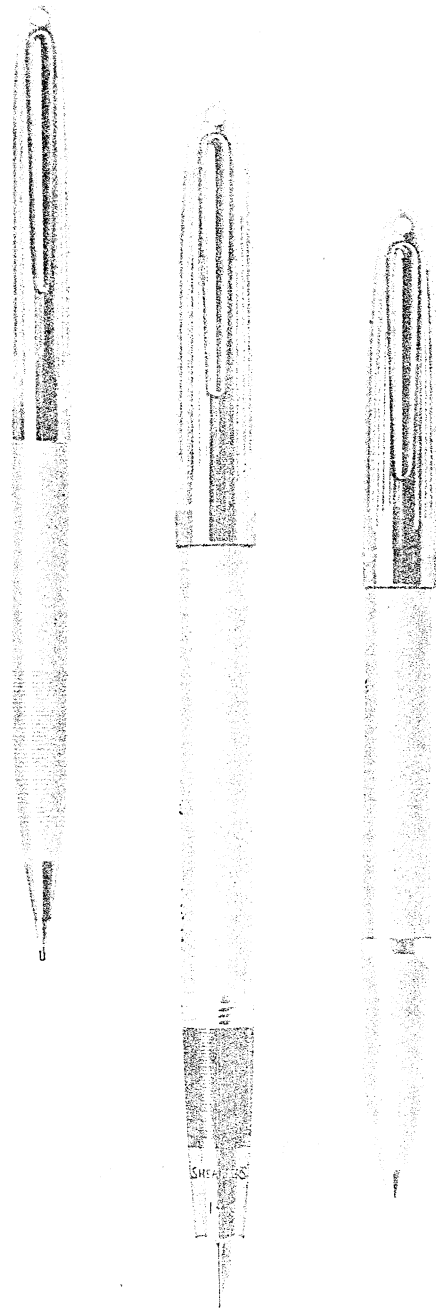

# *Sheaffer's Sentinel*

*New **SNORKEL** pen  
with matching ballpoint and pencil*

# Sheaffer's Valiant

New **SNORKEL** pen  
with matching ballpoint  
and pencil

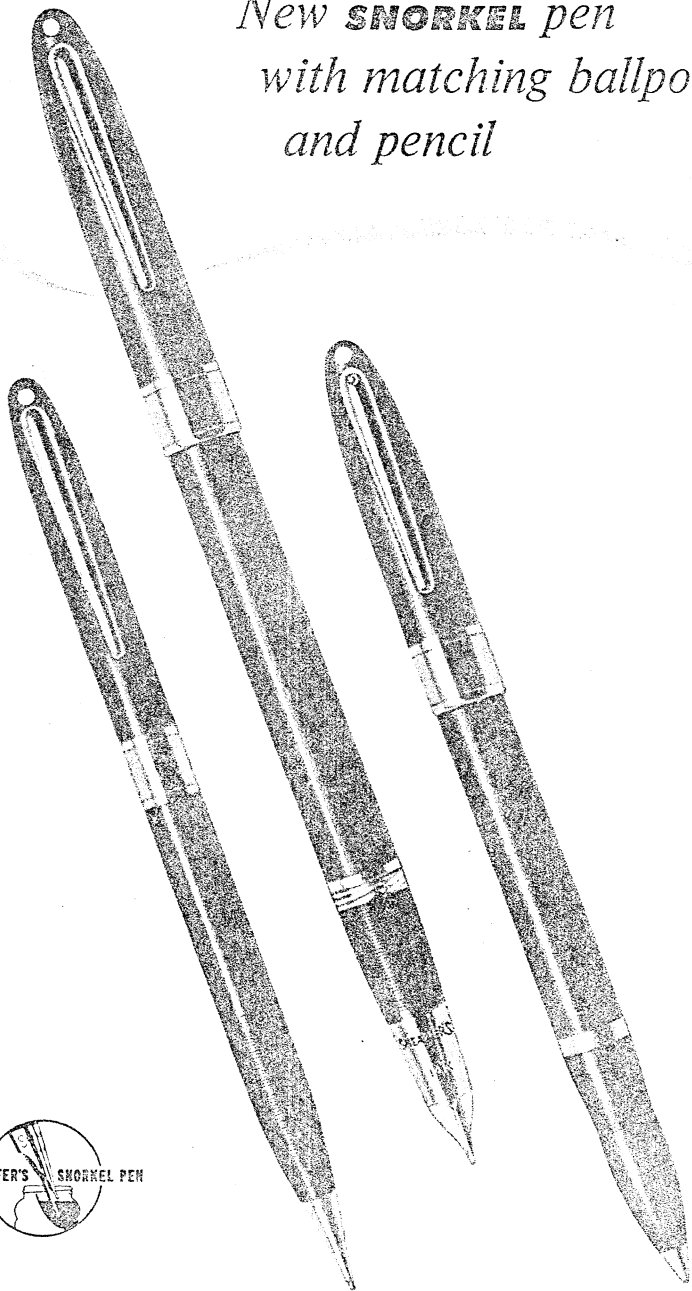

Every Sheaffer's feature and advancement is incorporated in the popular-priced Valiant. Rich-glowing caps and barrels are set off by gold-filled clips and trim. Smartly styled in Sheaffer's distinguished design to combine beauty with writing comfort. Points of 14K gold.

COLORS: *Black, burgundy, pastel green, aqua, grey.*

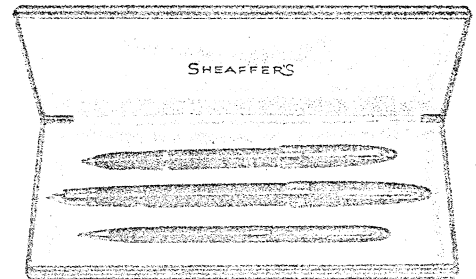





# Sheaffer's Clipper

New **SNORKEL** pen

with matching ballpoint  
and pencil



Sheaffer's distinctive use of color, set off by silver-toned chased caps adds richness to the Clipper. Pen points are ground to individual exactness in Sheaffer's new palladium-silver, a precious metal combination developed to assure lasting writing quality. Gold-filled trim on all caps.

COLORS: *Black, burgundy, pastel green, aqua, grey.*

# Sheaffer's Statesman

New **SNORKEL** pen  
with matching ballpoint  
and pencil

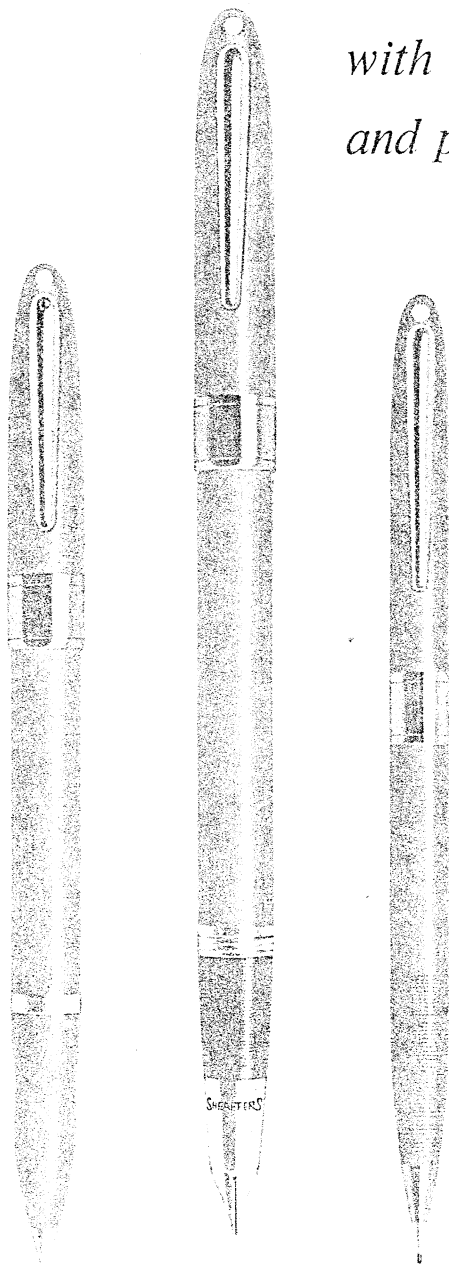

The glint of gold accents the soft, rich colors of this model. The Statesman features Sheaffer's new and enduring palladium-silver point, a costly combination of precious palladium, sterling and 14K gold. Outstanding value, sure to inspire proud ownership.

COLORS: *Aqua, burgundy, pastel green, black, grey.*

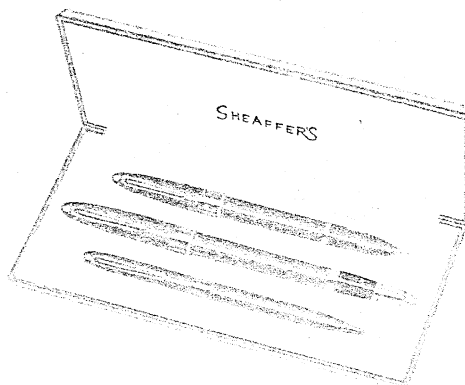



The classic simplicity of Sovereign's lines with its sparkling metal cap marks it as a true Sheaffer's creation. Its advanced features, likewise, are distinctively Sheaffer's. Smooth, 14K gold point in a wide selection of writing styles, highest quality throughout. Modestly priced.

COLORS: *Black, pastel green, burgundy, aqua, grey.*

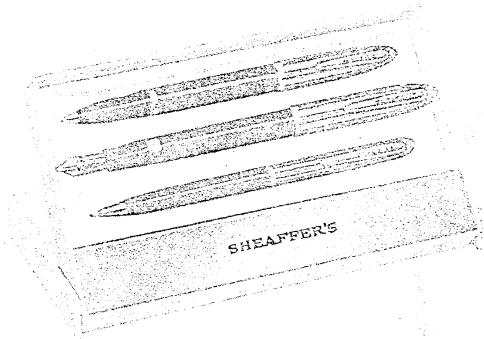
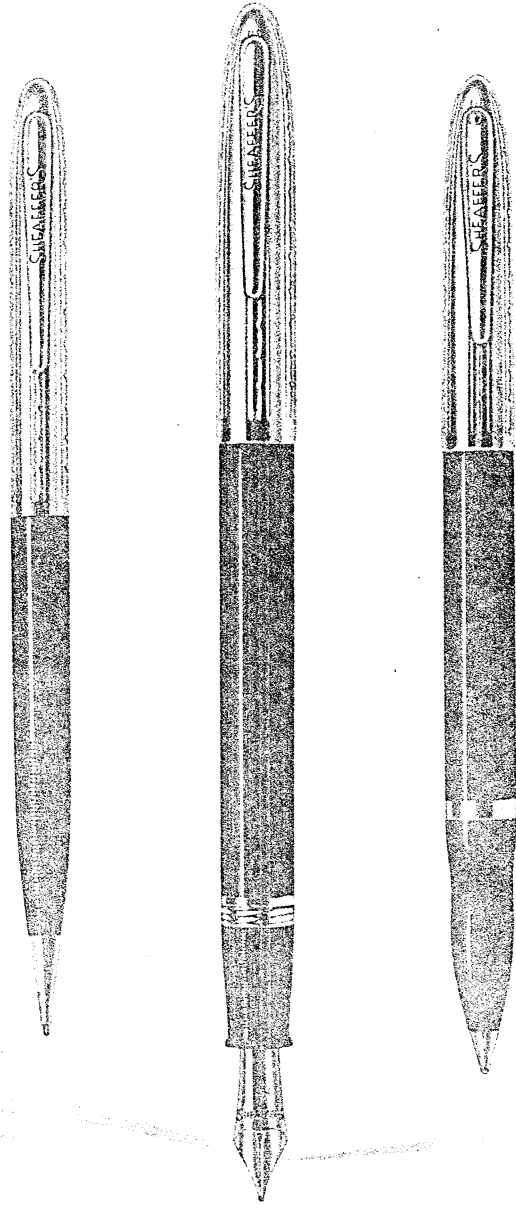

# Sheaffer's Sovereign

New **SNORKEL** pen

with matching ballpoint and pencil

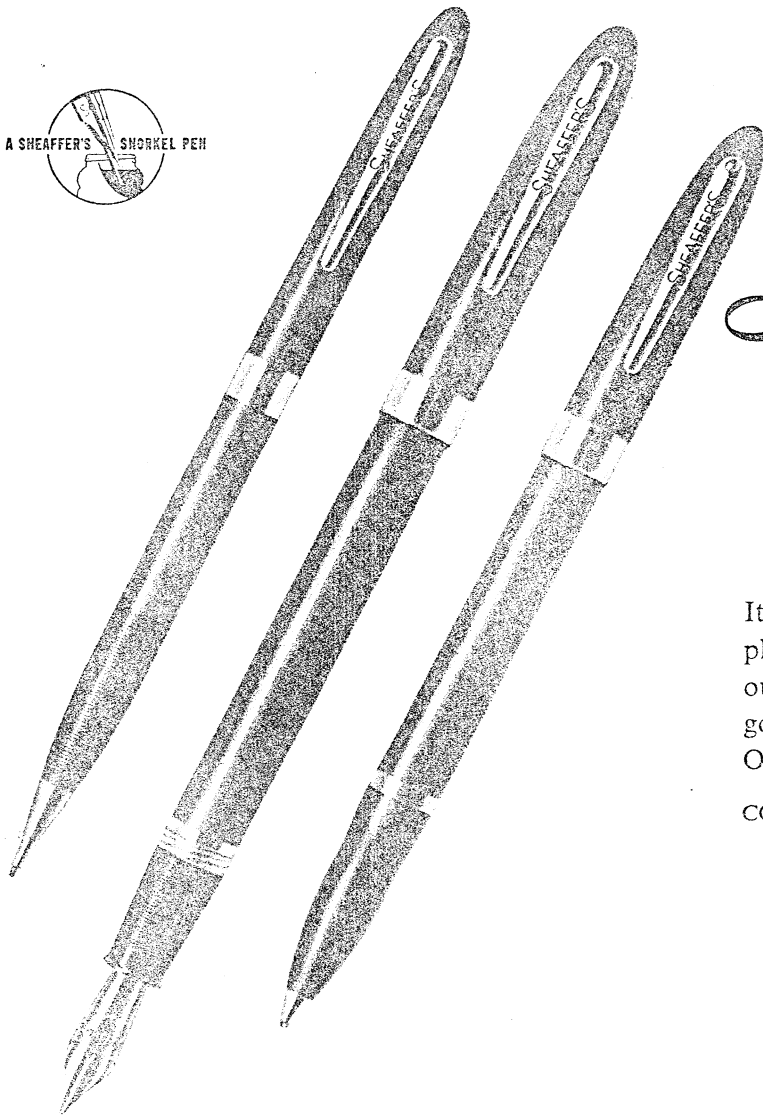

## Sheaffer's Saratoga

New **SNORKEL** pen  
with matching ballpoint  
and pencil

Its very design forecasts writing comfort and pleasure! Saratoga is a trim model, replete with outstanding features at a moderate price. Its 14K gold point flows words smoothly, effortlessly. Ownership, truly, is a constant source of pride.

COLORS: *Black, burgundy, aqua, grey, pastel green.*

## Sheaffer's Admiral

New **SNORKEL** pen  
with matching ballpoint  
and pencil

Sheaffer's popular-priced favorite is now a Snorkel pen! Long the choice of those who prefer quality coupled with economy, Admiral is now an even greater value. Distinctive Sheaffer styling, smooth-writing 14K gold points, and new exclusive advancements set the new Admiral far above its class.

COLORS: *Black, burgundy, grey, aqua, pastel green.*

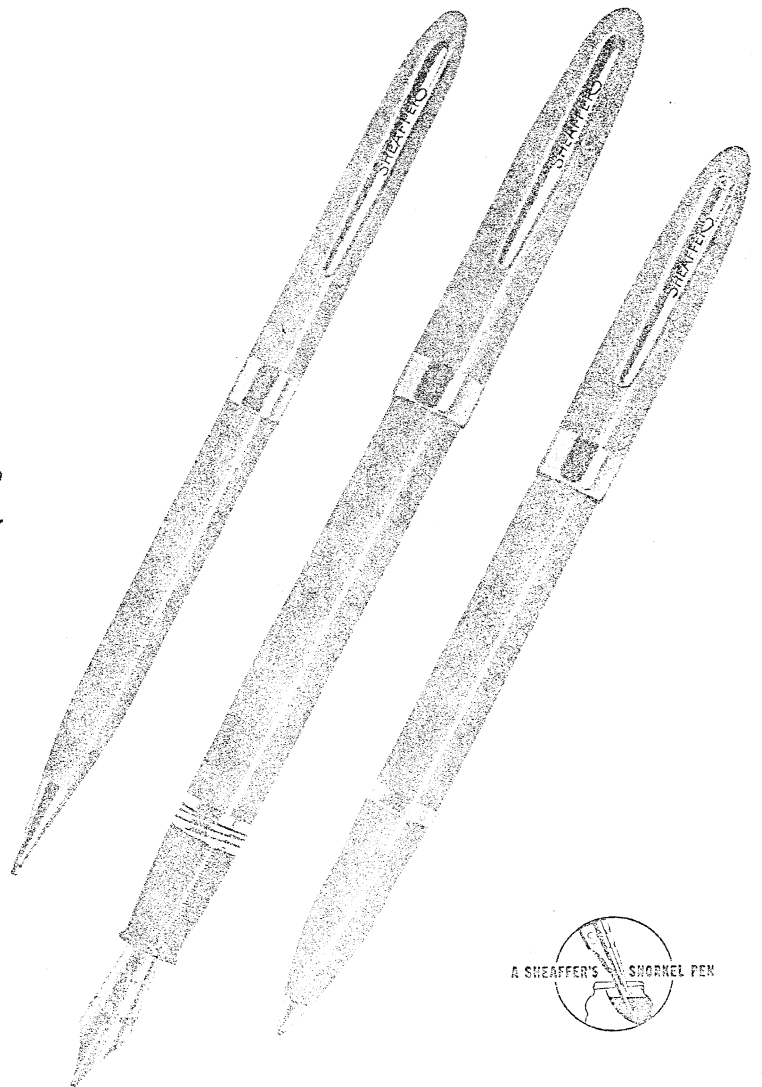

# Sheaffer's Craftsman

## TIP-DIP PEN WITH MATCHING PENCIL

Undisputed value leader in the low-priced field! Craftsman introduces "Tip-Dip"—surpassed in cleanliness only by the famous Snorkel Pen. A handsome new model designed to provide highest quality at modest cost.

COLORS: *Black, burgundy, grey, aqua, pastel green.*

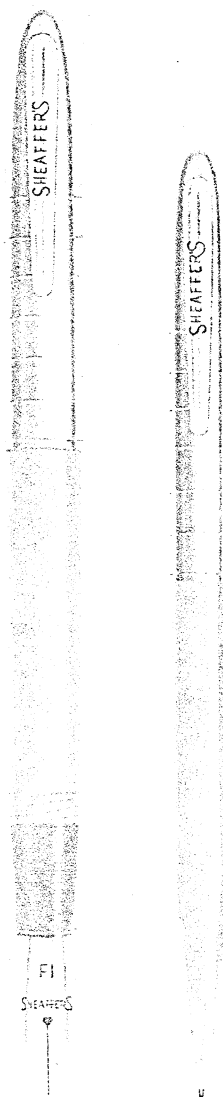

# Sheaffer's TIP dip

A new Sheaffer's development makes clean filling possible in even the lowest-priced pens! With Tip-Dip action, points and barrels no longer need be submerged for efficient, complete

### SHEAFFER'S FIRM POINTS

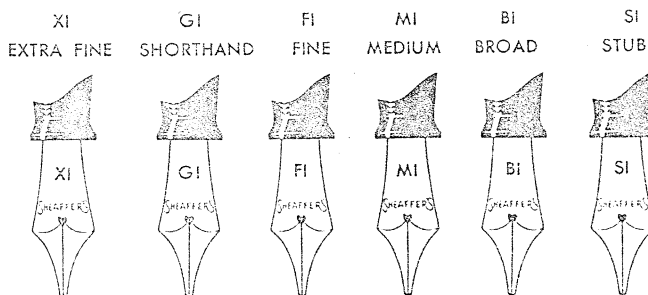

### SHEAFFER'S

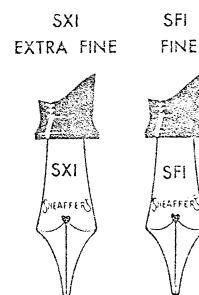



# Sheaffer's Cadet

## TIP-DIP PEN WITH MATCHING PENCIL

Sheaffer's brand new entry in the budget-price class offers quality and advancements found in no other. Cadet is an excellent starter pen for students with its smooth-flowing point and other pride-inspiring features that promote better penmanship. COLORS: *Black, burgundy, grey, aqua, pastel green.*

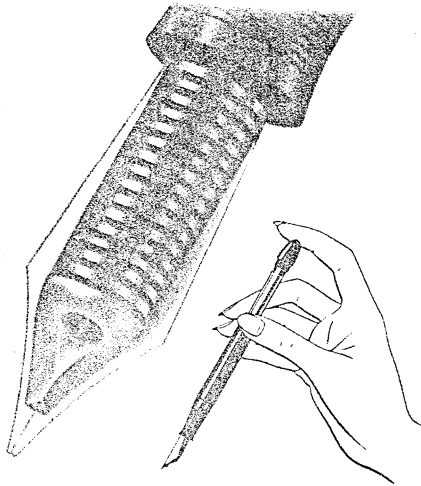

filling. Only the tip is dipped, ending the annoyance of ink-stained fingers and hands! Another outstanding advancement available only in Sheaffer's!

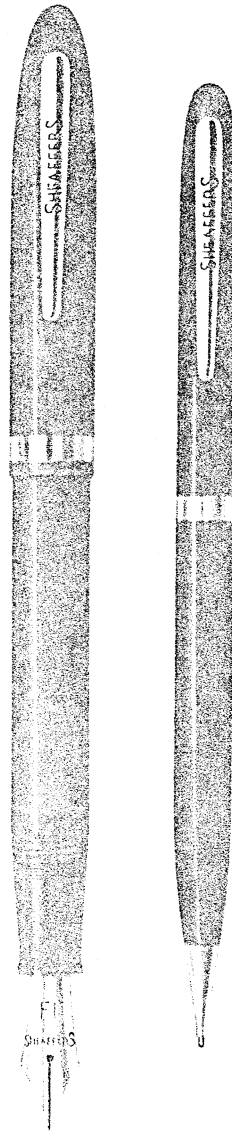

### SEMI-FLEXIBLE POINTS

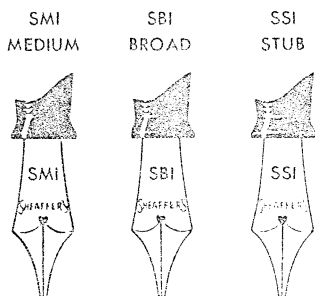

### SHEAFFER'S FLEXIBLE POINTS

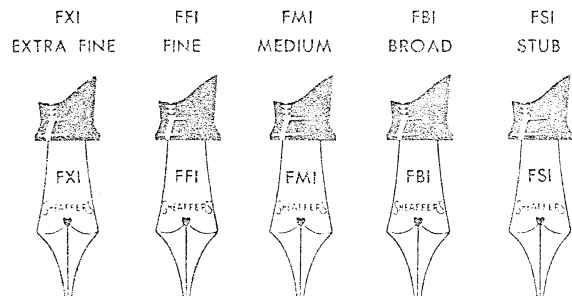

# Sheaffer's "CLICKER"

RETRACTABLE BALLPOINT

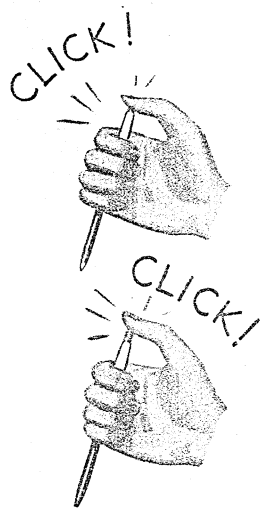

It's ready  
to write!

It retracts!

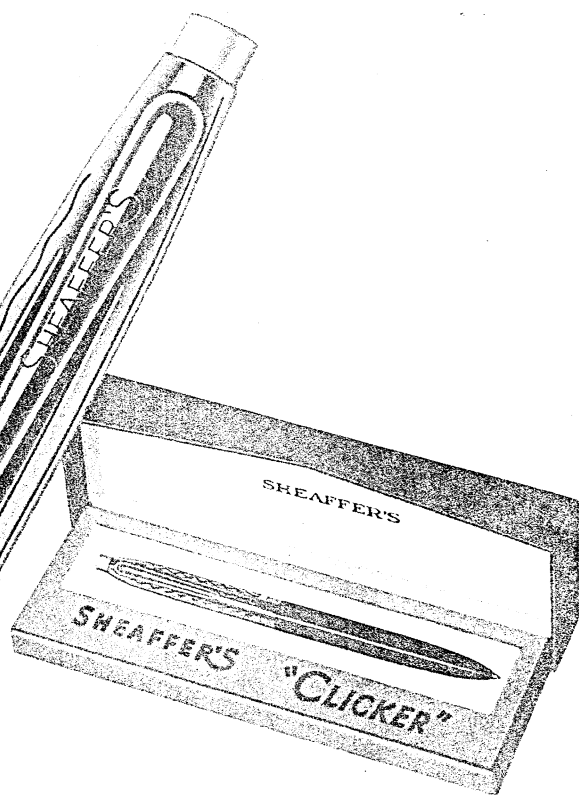

## A QUALITY WRITING INSTRUMENT NOT A GADGET

Here's the answer to the public demand for a ballpoint that's really worth keeping. Sheaffer's new Clicker is a precision-engineered ballpoint pen with quality in every detail. Mechanism is positive, precise. The strong tension-type clip and other trim details are gold filled, creating a rich contrast with the chased stainless metal cap. Definitely not the "throw away" kind, Clicker is a proud possession designed to give years of writing pleasure and satisfaction.

## HOLDS FIVE TIMES AS MUCH INK

A single Clicker unit will outlive five other cartridges. And a new system of pressure control assures full use of the maximum amount of fluid. Jewel-tipped Clicker unit assures smoothest writing.

## WRITING WON'T FADE OUT—EVER

Permanent blue-black ink in the Clicker unit remains legible as long as the paper lasts! Can be used for records that require reference for years and years. Dries instantly, smudge-proof, won't transfer! Clicker unit also comes in other colors; green, red, purple.

*Exclusive  
ruby-tipped  
CLICKER  
writing unit*

The hardness and high, smooth polish of the ruby tip is reflected in smooth, even writing. Glides words on all grades of paper—on glossy or rough surfaces—without the annoying skips of cheaper, steel ball tips.



RUBY TIP

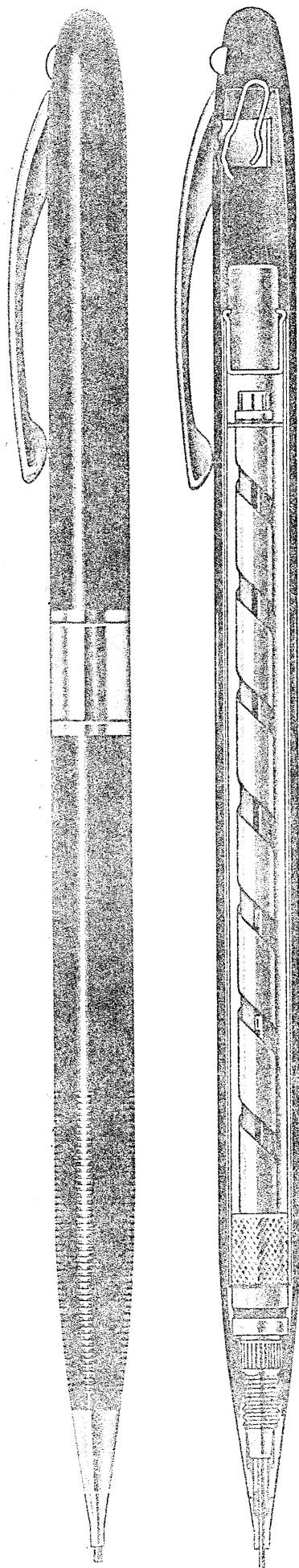

Exclusive, innerspring clip holds safely, firmly to any fabric, thick or thin.

Convenient lead storage compartment carries a big supply of "spares."

New 17% slimmer design adds beauty, balance, writing ease.

Mechanism is shielded against shock, damage or tampering. Precision-fitted for smooth operation.

"Viewpoint" tip steadies lead—reduces breakage.

# Sheaffer's Utility Pencil

Economy priced, the new Utility Pencil gives you the benefits of Sheaffer's precision features in a trim, tailored design. The most popular pencil in America!

Extensible eraser can be adjusted for full usage simply by turning screw.

FULL LENGTH ERASER SHORT SCREW  
WORN ERASER LONG SCREW

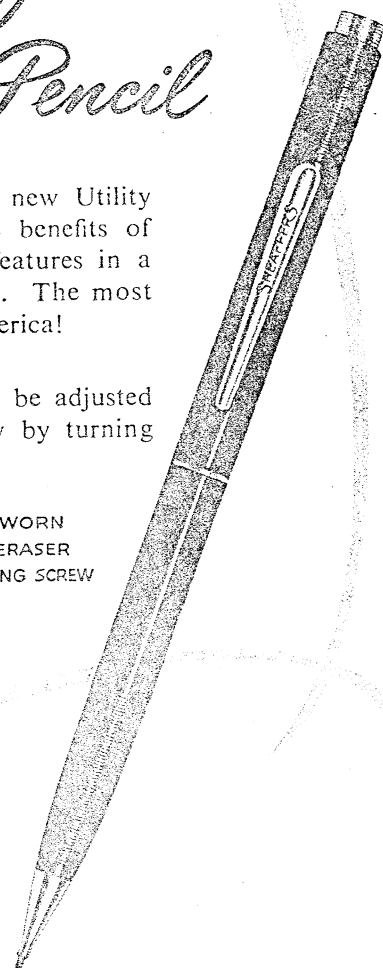
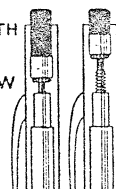

**SHEAFFER'S THIN PENCIL . . . New slim design with a style to match every Sheaffer Pen**

The same precision, craftsmanship and quality that set Sheaffer pens apart is evidenced in Sheaffer's pencil made to match every model. Used more often than any other writing instrument, it is built to withstand hard, frequent usage, with its shielded mechanism housed in a design of slender, distinguished beauty.

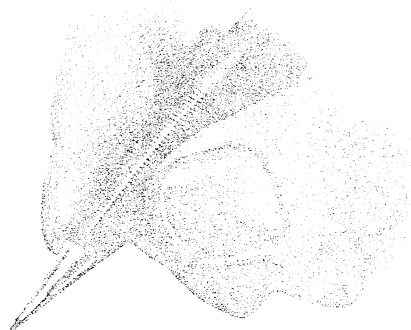

*Sheaffer's*  
**DESK SETS**  
*with the*  
*new*  
**SNORKEL**  
*pen*

**DESK MODEL  
 SNORKEL PEN**

This slender tapering version of Sheaffer's Snorkel Pen is especially convenient for the executive to whom cleanliness and a generous reservoir of ink are important. Also available with conventional point.

**DESK MODEL  
 BALLPOINT**

Long-hand memos, notations and a host of other needs are served by this slim, handy, dependable desk ballpoint with a choice of different colored inks.

**MATCHING DESK  
 PENCIL**

Always at hand, always ready to write, this pencil is used constantly throughout the working day. Its beauty and balance accord it a place of honor in this handsome grouping.

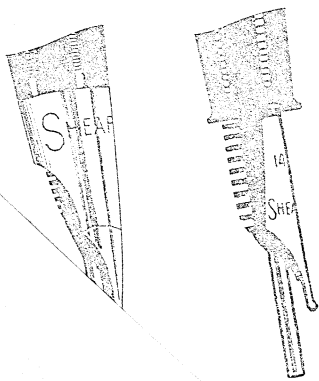

CONVENTIONAL

with either  
 conventional point  
 ballpoint or  
 with

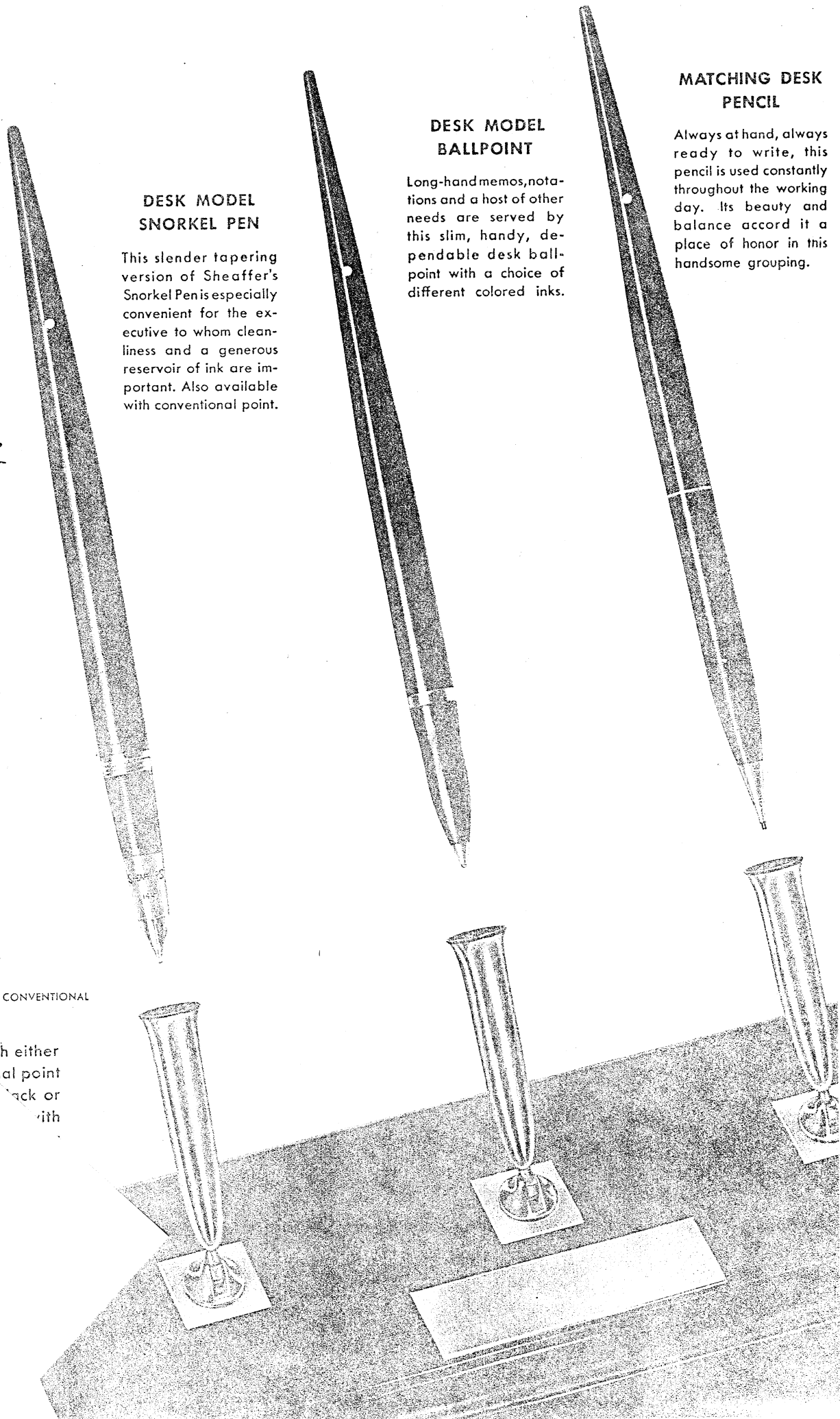

**THE WORLD'S MOST BEAUTIFUL  
ONYX, CRYSTAL AND MARBLE  
MAKE SHEAFFER'S DESK SETS  
THE LINE OF DISTINCTION**

**A. JET CRYSTAL**

Clean, gleaming beauty is achieved by meticulous hand polishing of high luster, black glass crystal. In manufacture, it is hard-fired to resist chipping. In processing, it is cut and polished with infinite care to achieve designs to enhance any surroundings, modern or traditional.

**B. MEXICAN ONYX**

This south-of-the-border product is also quarried in the southwestern United States. Its beautiful striations are brought out by a special polishing operation that applies a jewel-like finish to the surface of carefully-selected specimens.

**C. BELGIAN ONYX**

From old-country quarries comes this rich stone that lends its natural beauty to Sheaffer Desk Sets. Delicate white tracings are evident throughout the polished black surface—the expert appraiser's test for determining the genuine.

**D. ITALIAN MARBLE**

Traditionally the stone of artisans, marble serves the same purpose in Sheaffer desk sets. Selected from its old world source, it is a gracious addition to modern American homes and offices.

**E. SPANISH ONYX**

A rich, brown stone which had its origin in Spain, this onyx polishes to a regal luster. Blends beautifully with any desk wood. New veins of this material have been opened in Africa which now provides the supply for Sheaffer bases.

**F. BRAZILIAN ONYX**

This exquisite onyx has its origin high in South American mountains. It is cut into slabs and graded for quality and veining. Sheaffer selects only the most uniform, beautifully grained onyx to polish and finish for bases.

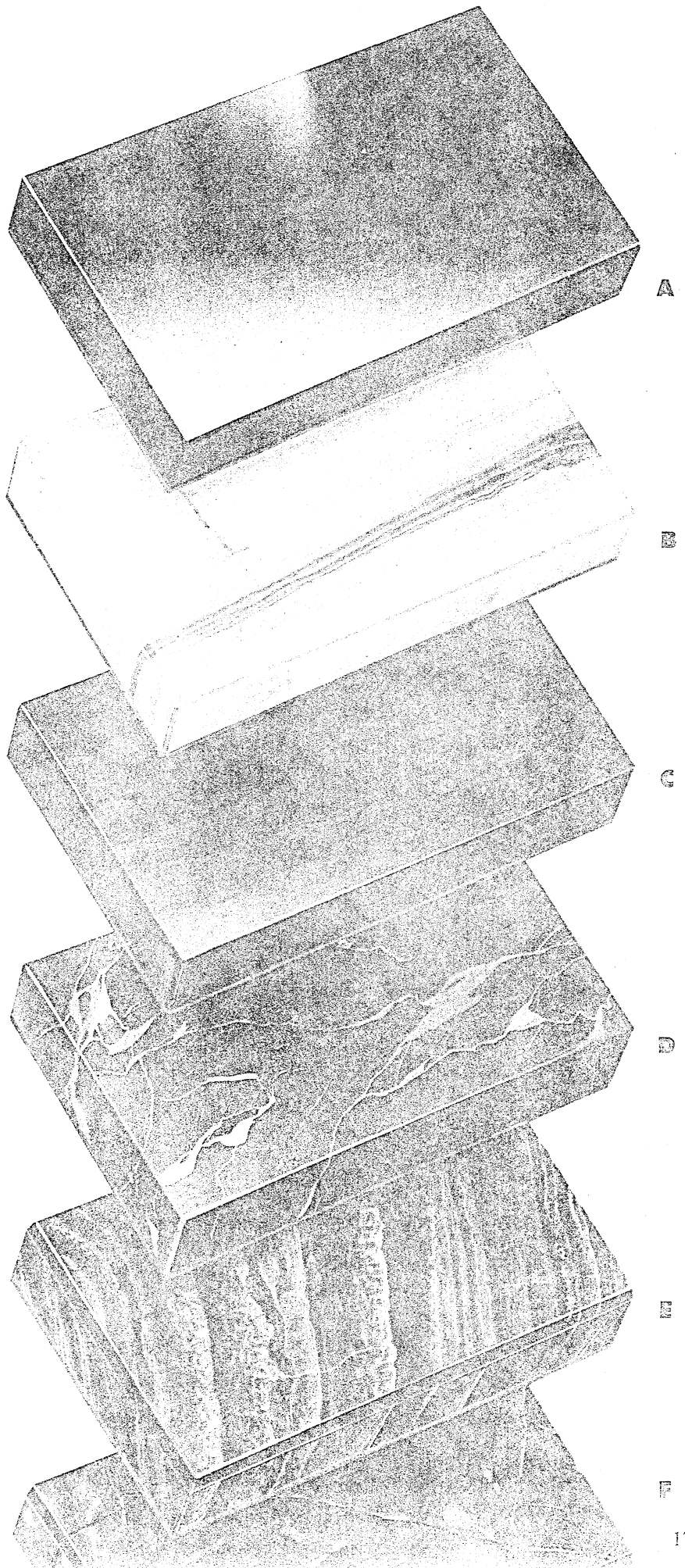

A  
B  
C  
D  
E  
F



*JOE*

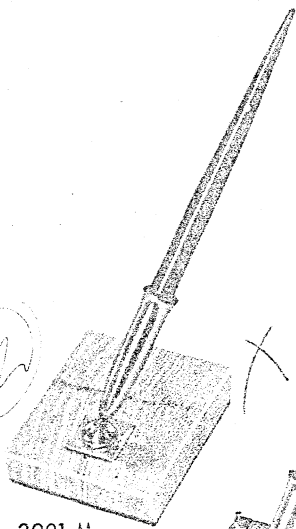

2001-M

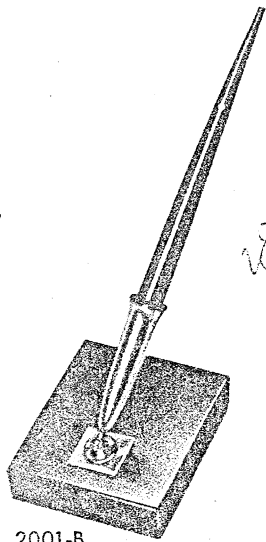

2001-B

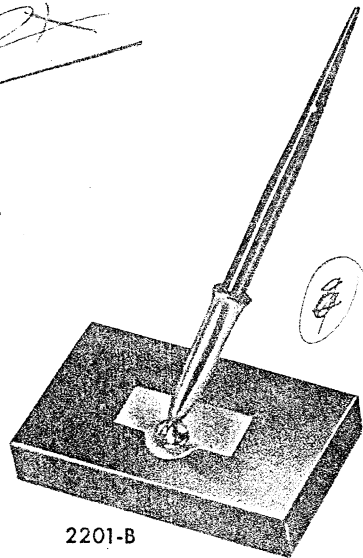

2201-B

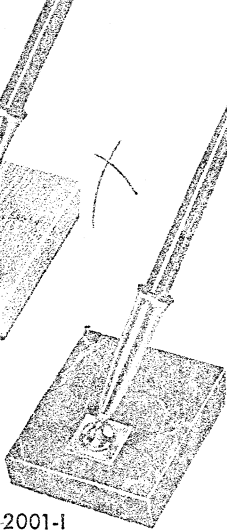

2001-I

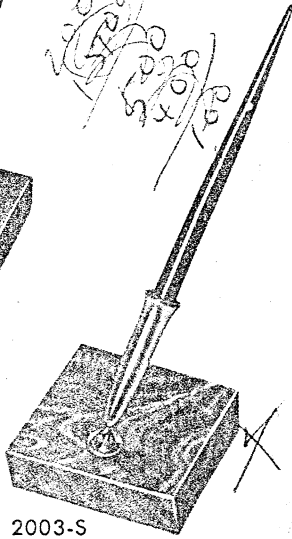

2003-S

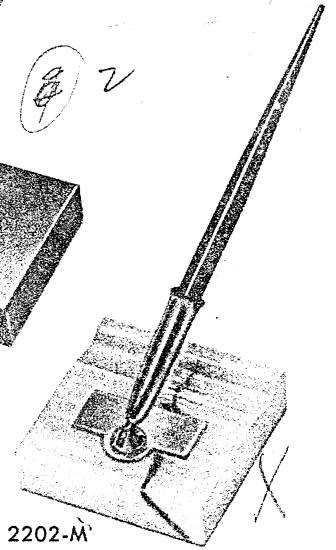

2202-M

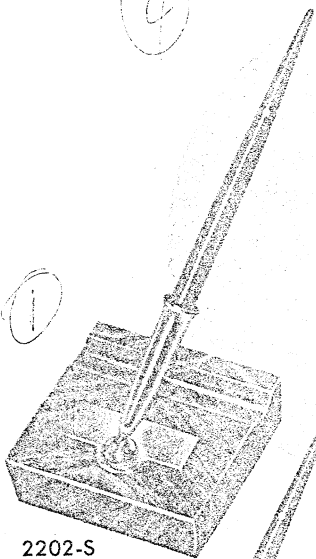

2202-S

2001-M  
Mexican Onyx  
Base Size 2 3/4" x 3 1/4"

2001-B  
Belgian Onyx  
Base Size 2 3/4" x 3 1/4"

2205-G  
Brazilian Onyx  
Base Size 2 3/4" x 3 1/4"

2501-J  
Jet Crystal  
Base Size 3 3/4" x 6 1/2"

2202-S  
Spanish Onyx  
Base Size 3 1/2" x 3 1/2"

2203-S  
Spanish Onyx  
Base Size 3" x 3 1/2"

2201-B  
Belgian Onyx  
Base Size 3" x 5"

2204-I  
Italian Marble  
Base Size 3 1/2" x 5"

2206-B  
Belgian Onyx  
Base Size 3" x 5"

2501-M  
Mexican Onyx  
Base Size 3 3/4" x 6 1/2"

2001-I  
Italian Marble  
Base Size 2 3/4" x 3 1/4"

2003-S  
Spanish Onyx  
Base Size 2 3/4" x 3 1/4"

2202-M  
Mexican Onyx  
Base Size 3 1/2" x 3 1/2"

2203-M  
Mexican Onyx  
Base Size 3" x 3 1/2"

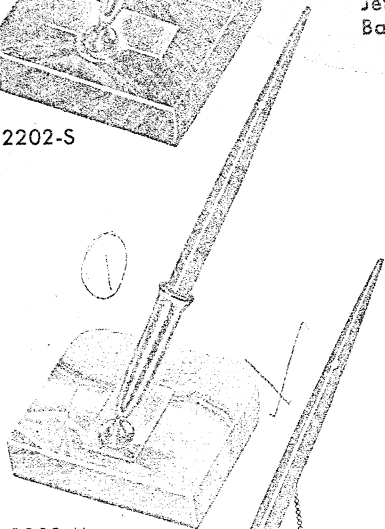

2203-M

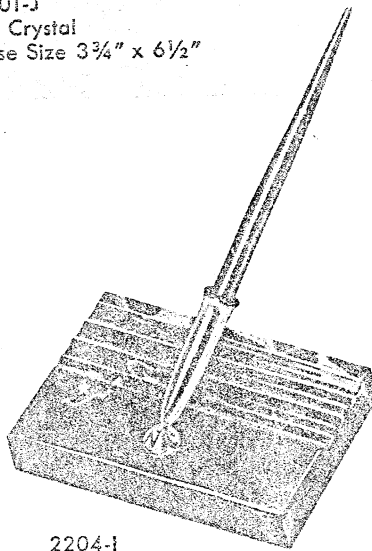

2204-I

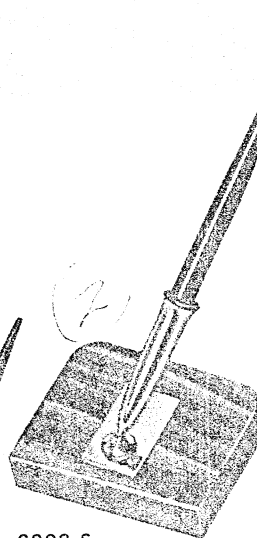

2203-S

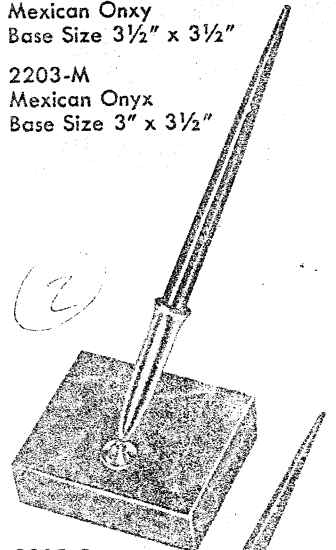

2205-G

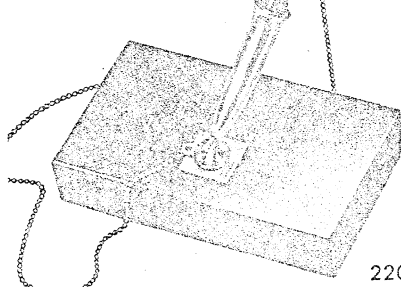

2206-B

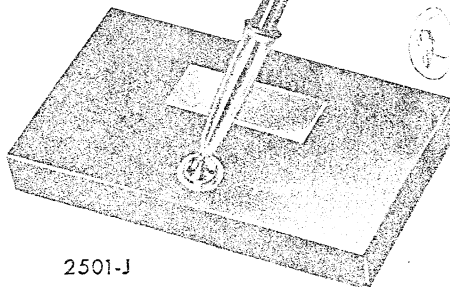

2501-J

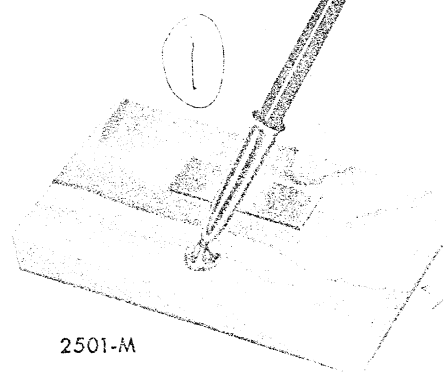

2501-M

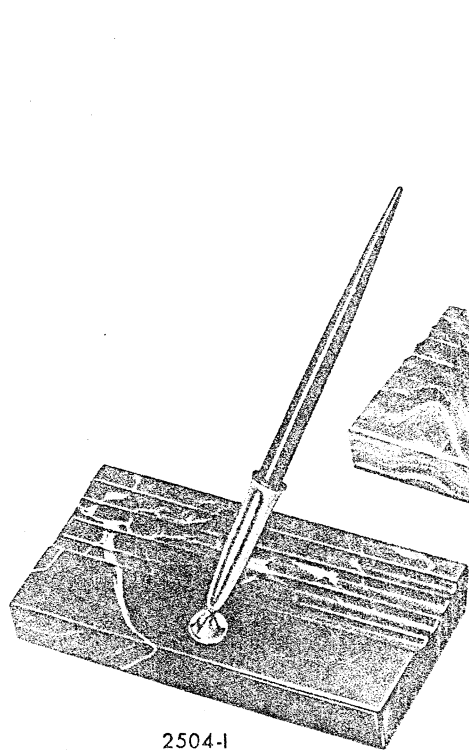

2504-I

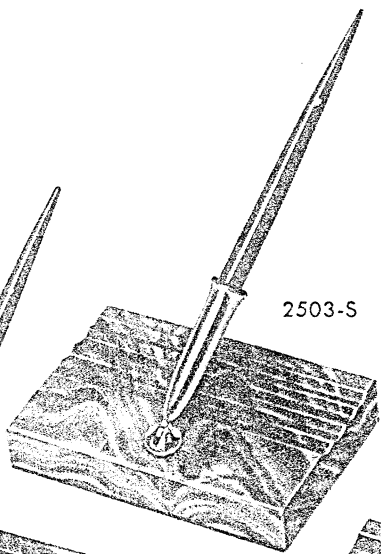

2503-S

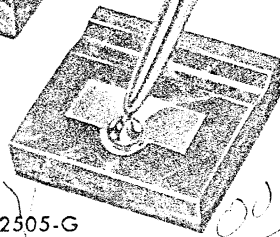

2505-G

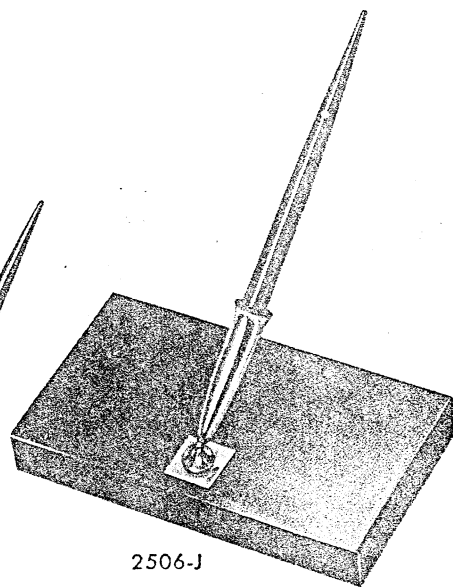

2506-J

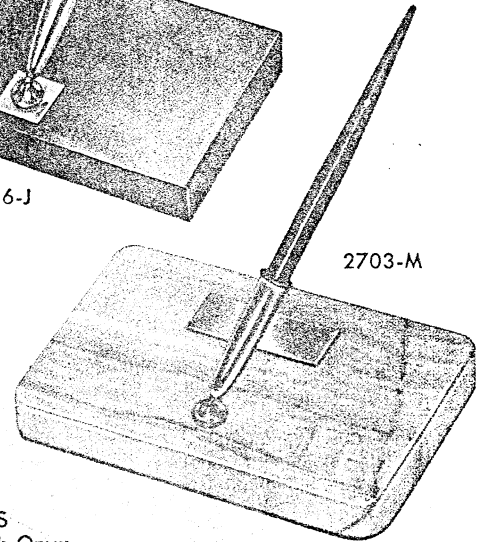

2703-M

2503-S  
Spanish Onyx  
Base Size 3 1/2" x 5"

2505-G  
Brazilian Onyx  
Base Size 3 1/2" x 3 1/2"

2701-J  
Jet Crystal  
Base Size 4" x 7 1/2"

2703-M  
Mexican Onyx  
Base Size 4 1/2" x 7"

2704-M  
Mexican Onyx  
Base Size 3 1/2" x 7"

2504-I  
Italian Marble  
Base Size 3 1/2" x 7"

2506-J  
Jet Crystal  
Base Size 3 3/4" x 6 1/2"

2702-J  
Jet Crystal  
Base Size 4 1/2" x 7"

2704-S  
Spanish Onyx  
Base Size 3 1/2" x 7"

2705-G  
Brazilian Onyx  
Base Size 3 1/2" x 5"

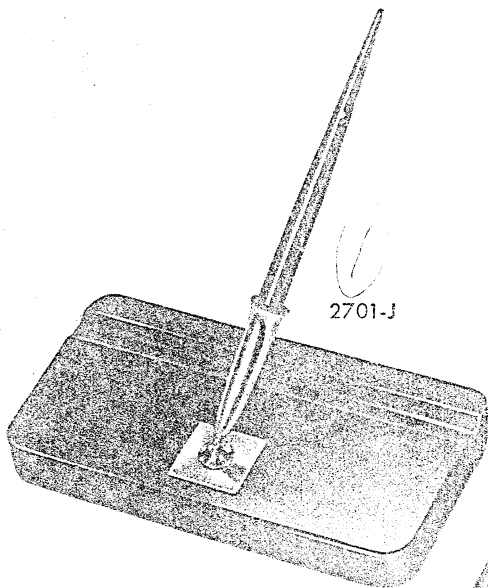

2701-J

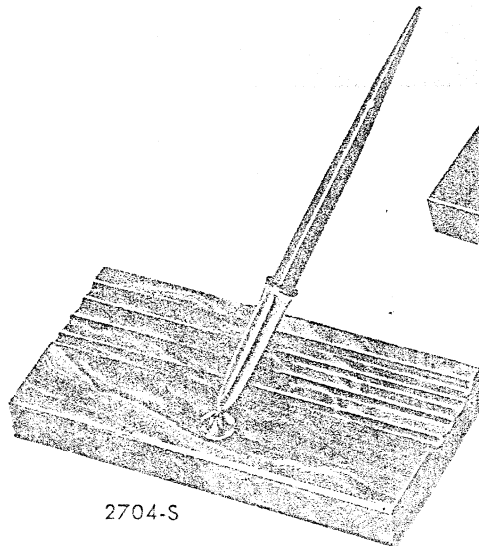

2704-S

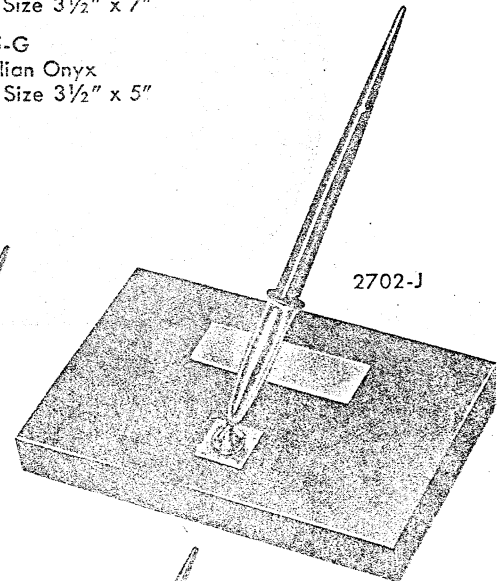

2702-J

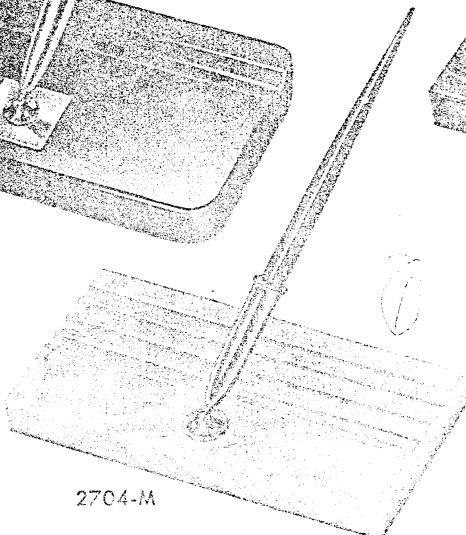

2704-M

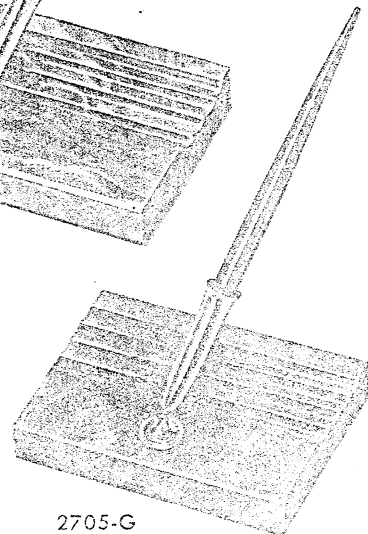

2705-G





3001-M

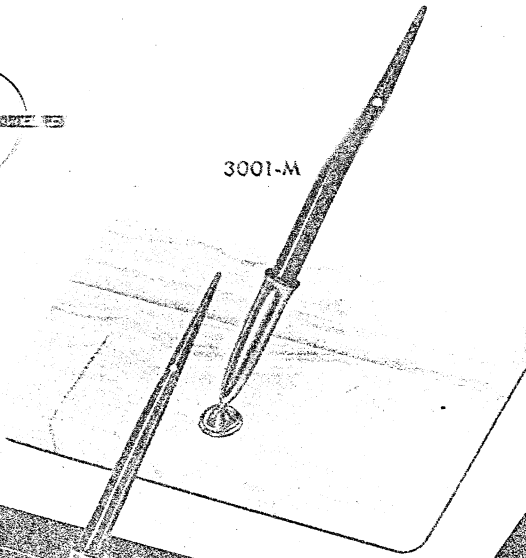

3002-M

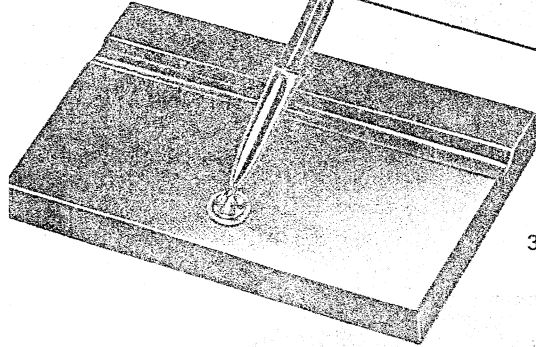
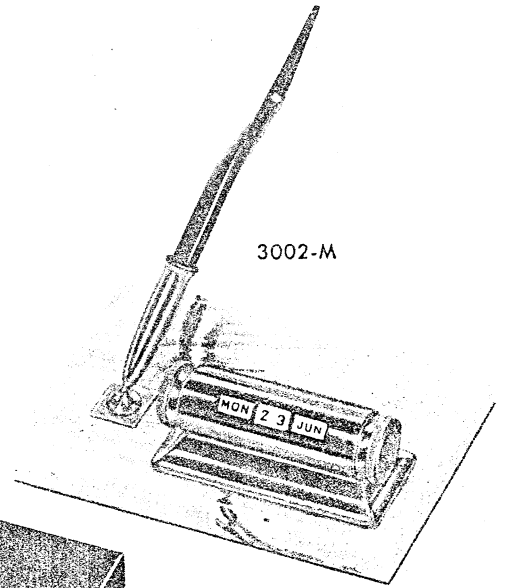

3001-J

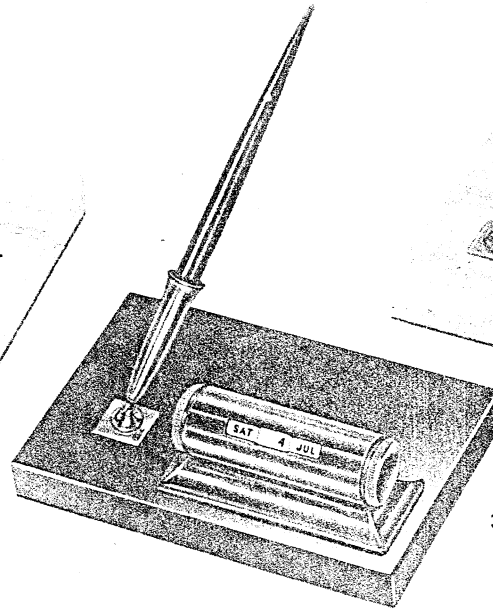

3002-J

3001-J  
Jet Crystal  
Base Size 5" x 8"

3003-S  
Spanish Onyx  
Base Size 3 3/4" x 6 1/2"

3001-M  
Mexican Onyx  
Base Size 5" x 8"

3004-G  
Brazilian Onyx  
Base Size 3 1/2" x 7"

3002-J  
Jet Crystal  
Base Size 4 1/2" x 7"

4201-I  
Italian Marble  
Base Size 7 3/4" x 13 1/2"

3002-M  
Mexican Onyx  
Base Size 4 1/2" x 7"

4501-J  
Jet Crystal  
Base Size 4" x 7 1/2"

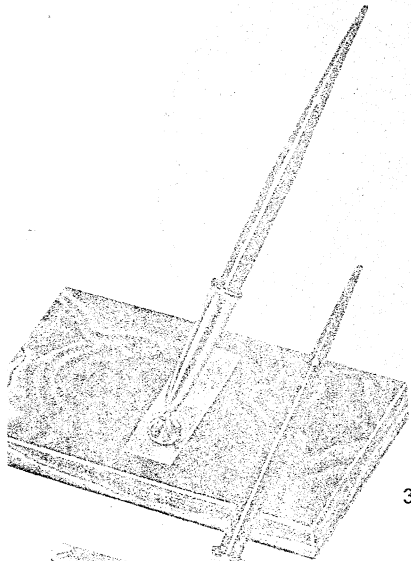

3003-S

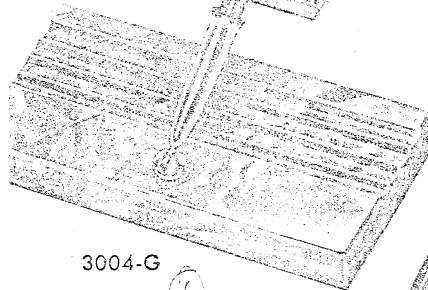

3004-G

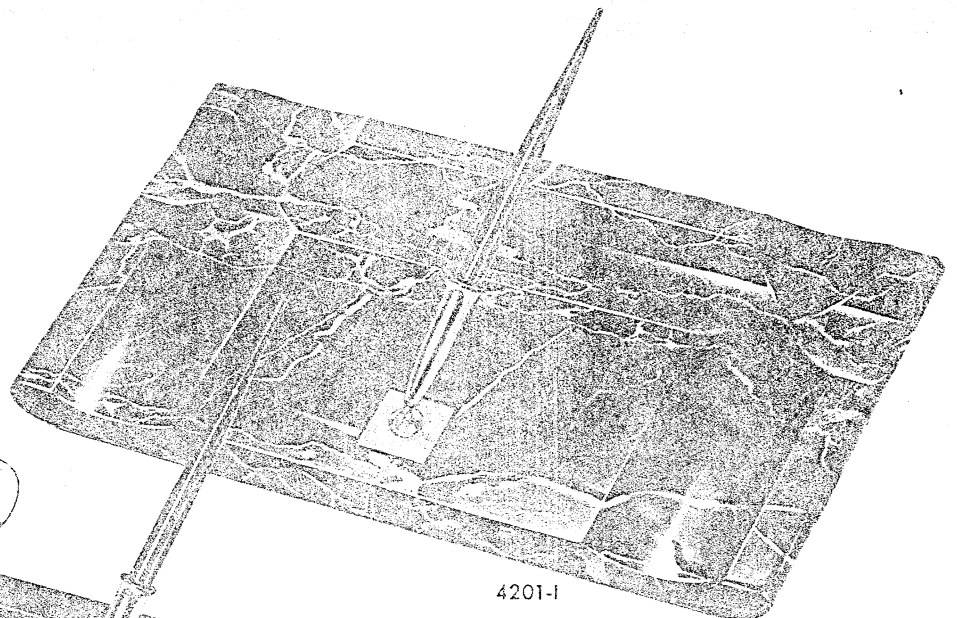

4201-I

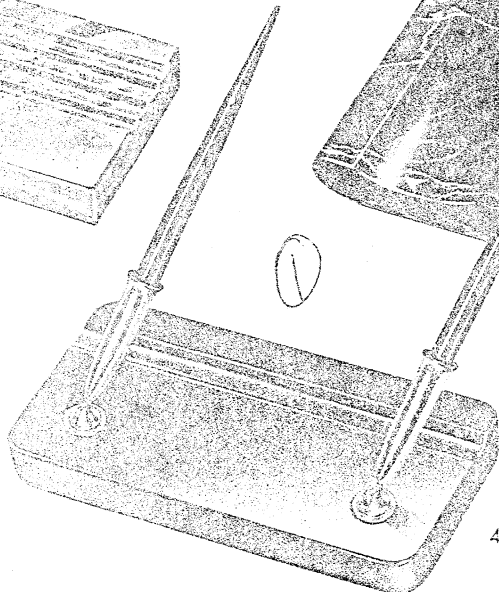

4501-J



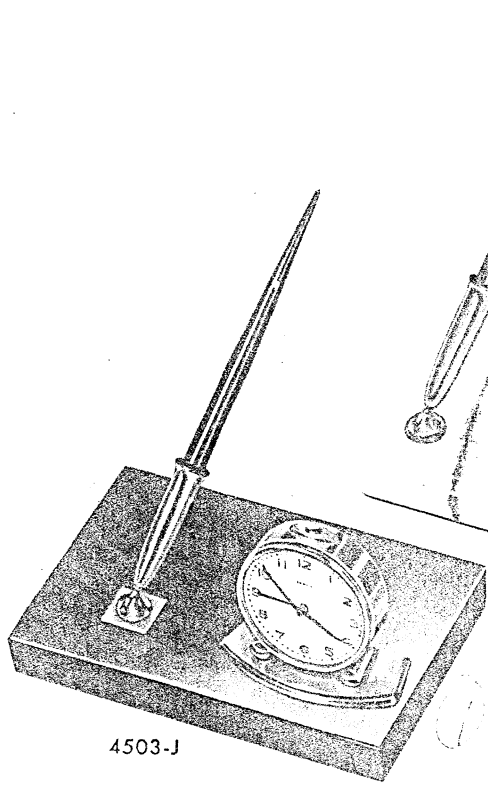

4503-J

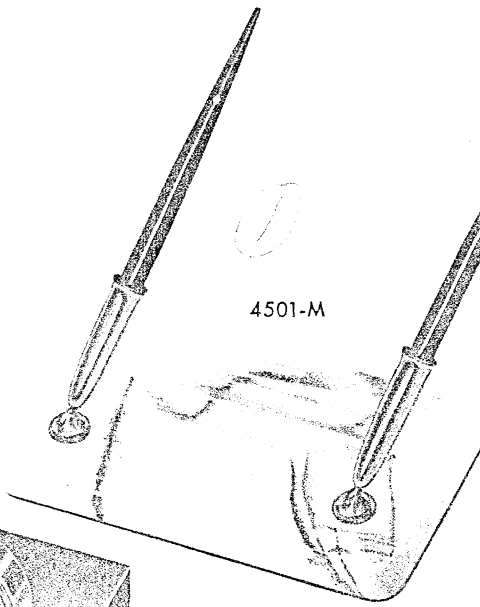

4501-M

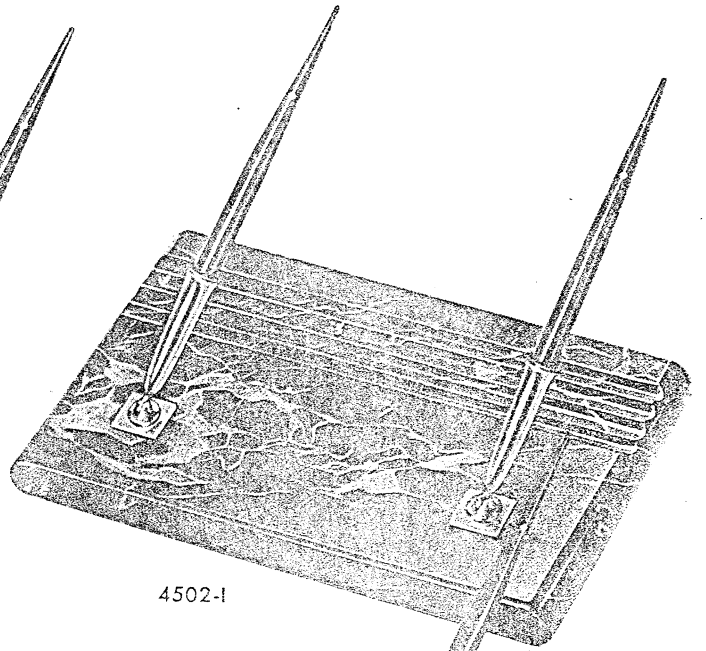

4502-I

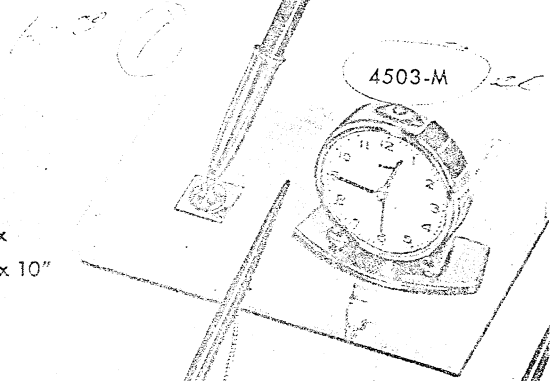

4503-M

4501-M  
Mexican Onyx  
Base Size 4" x 7½"

5001-J  
Jet Crystal  
Base Size 5" x 10"

4502-I  
Italian Marble  
Base Size 6½" x 10¼"

5001-M  
Mexican Onyx  
Base Size 5" x 10"

4503-J  
Jet Crystal  
Base Size 4½" x 7"

5002-J  
Jet Crystal  
Base Size 5" x 10"

4503-M  
Mexican Onyx  
Base Size 4½" x 7"

5003-J  
Jet Crystal  
Base Size 5" x 10"

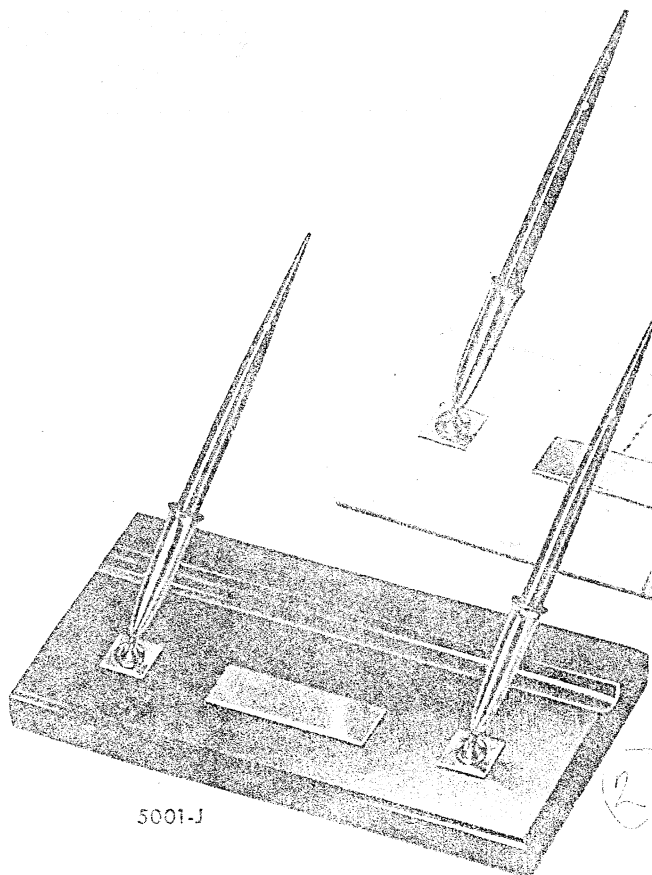

5001-J

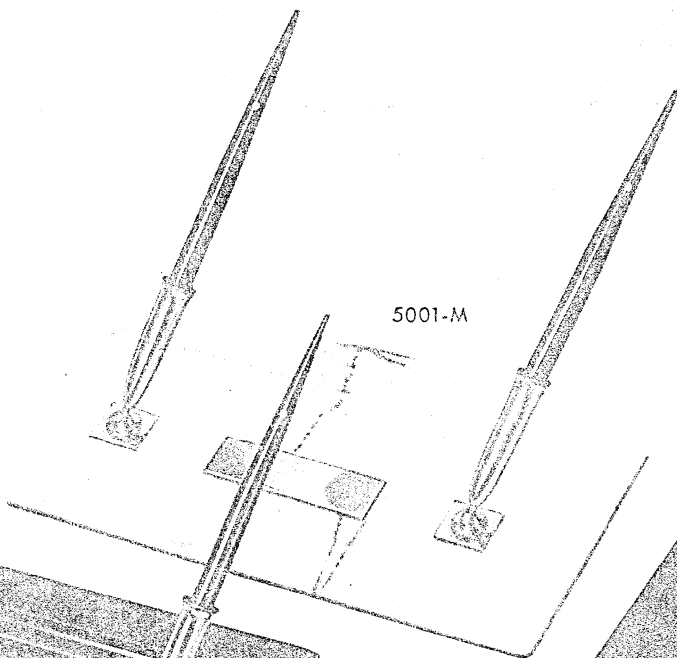

5001-M

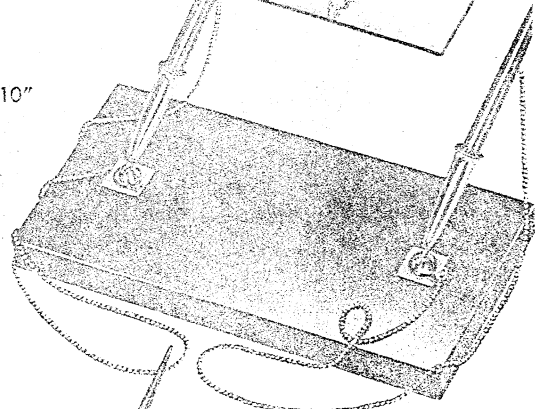

5003-J

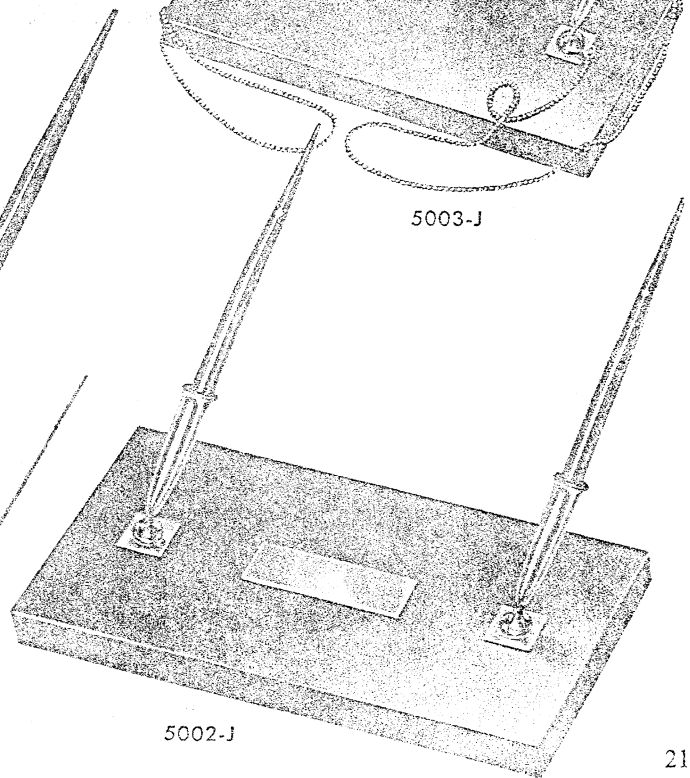

5002-J



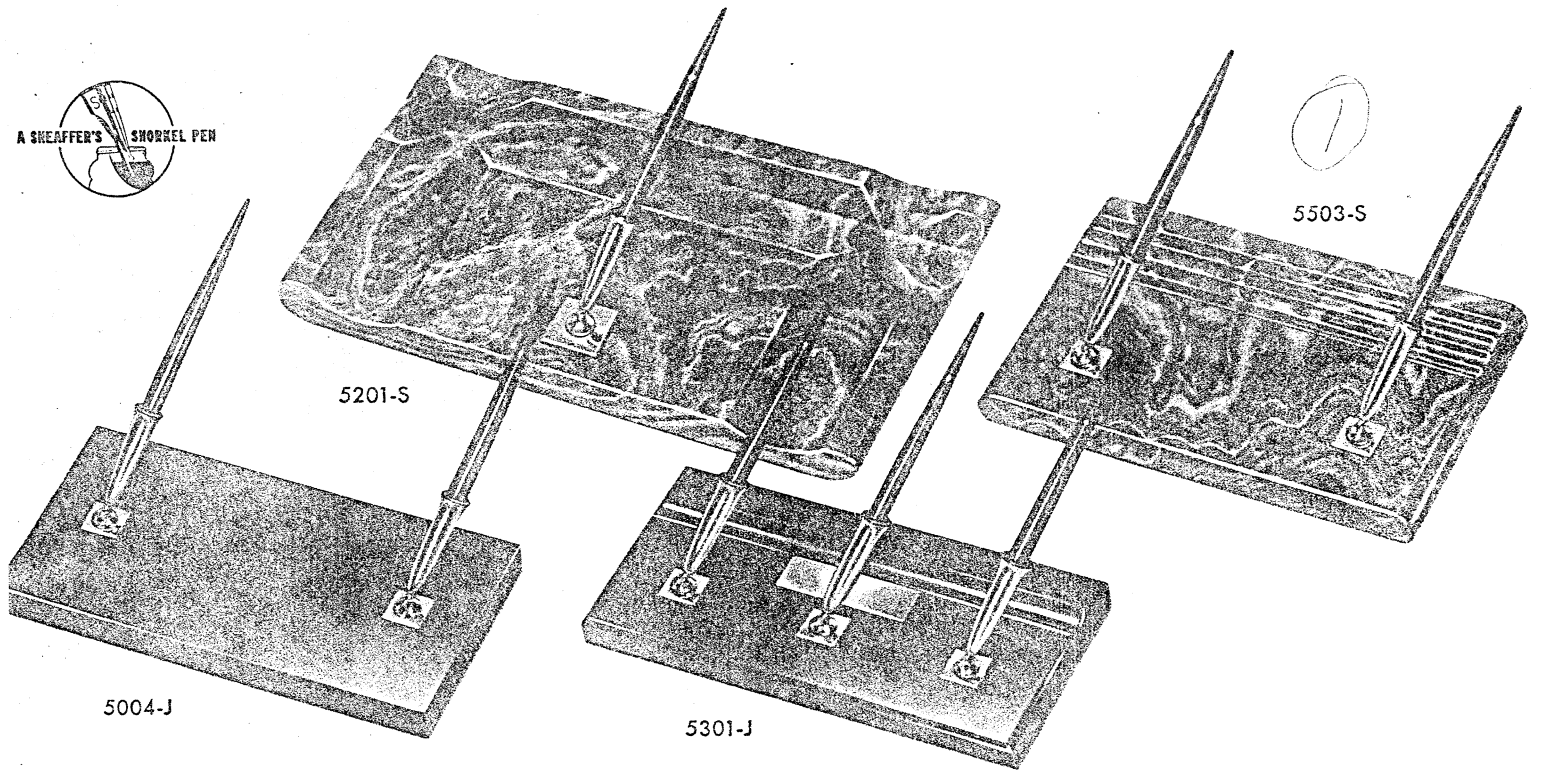

5004-J

5201-S

5301-J

5503-S

5004-J  
Jet Crystal  
Base Size 5" x 10"

5502-J  
Jet Crystal  
Base Size 8" x 14"

5201-S  
Spanish Onyx  
Base Size 7 3/4" x 13 1/2"

5503-S  
Spanish Onyx  
Base Size 6 1/4" x 10 1/4"

5301-J  
Jet Crystal  
Base Size 5" x 10"

6001-S  
Spanish Onyx  
Base Size 5" x 10"

5501-J  
Jet Crystal  
Base Size 5" x 10"

6002-I  
Italian Marble  
Base Size 7 3/4" x 13 1/2"

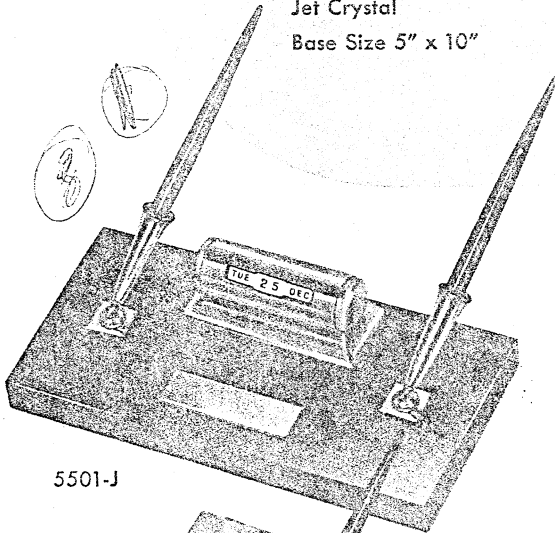

5501-J

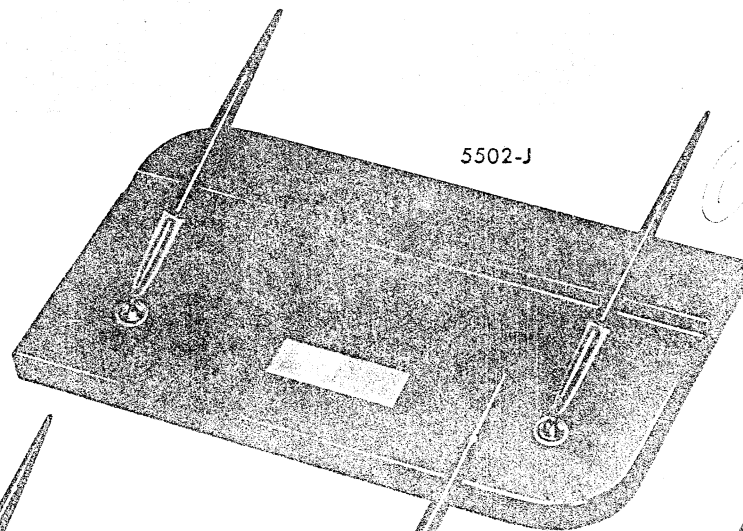

5502-J

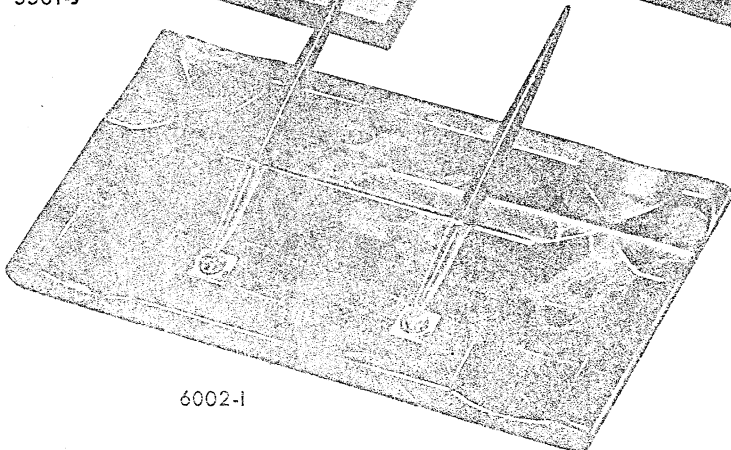

6002-I

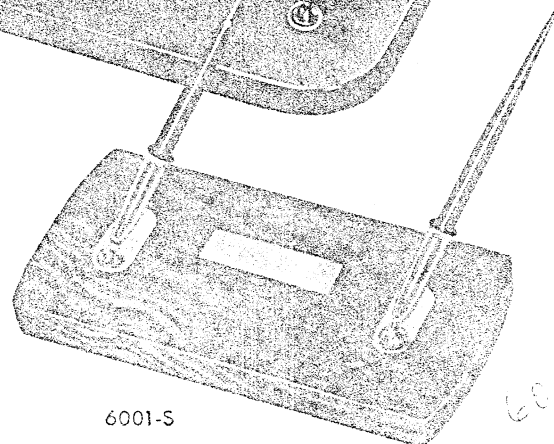

6001-S

6001-G



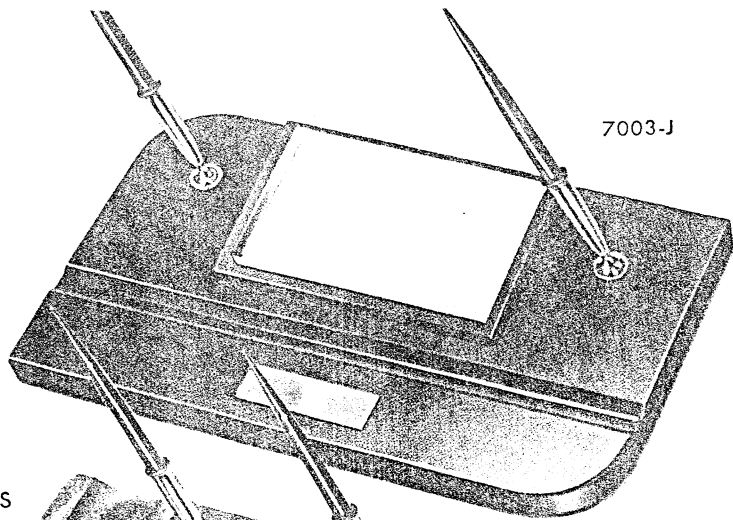

7003-J

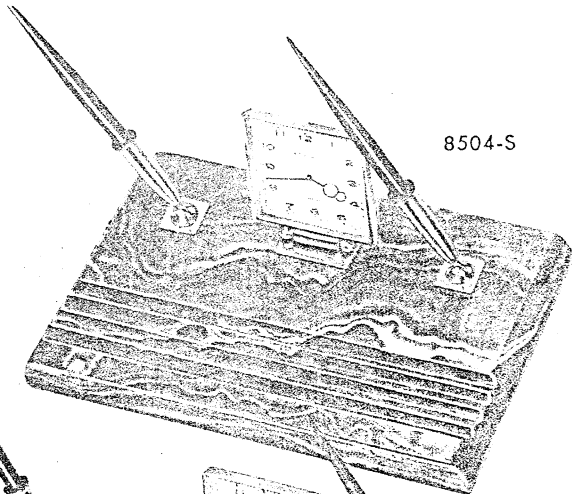

8504-S

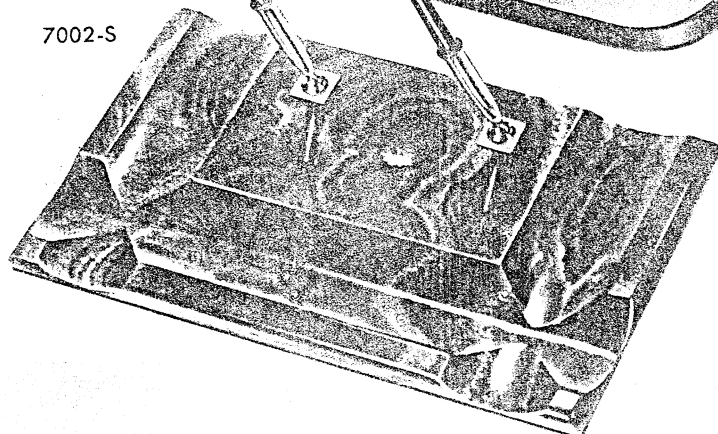

7002-S

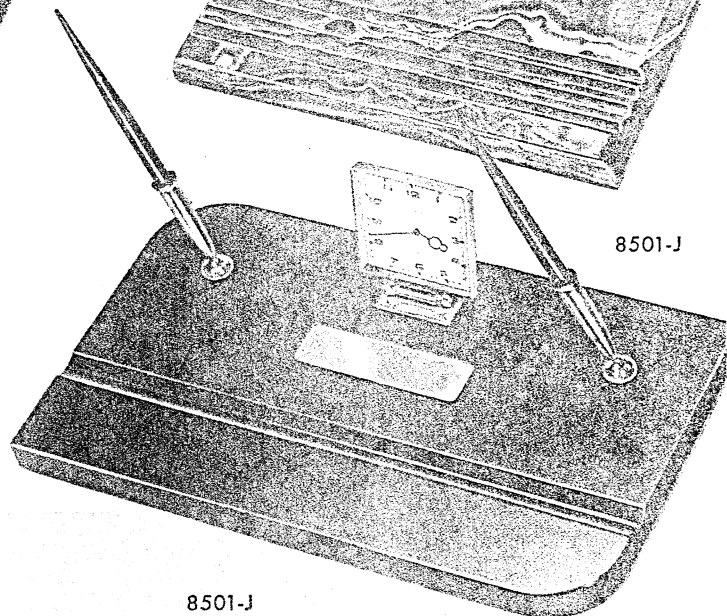

8501-J

7001-J  
Jet Crystal  
Base Size 5" x 10"

7501-M  
Mexican Onyx  
Base Size 8" x 14"

7001-M  
Mexican Onyx  
Base Size 5" x 10"

8501-J  
Jet Crystal  
Base Size 8" x 14"

7002-S  
Spanish Onyx  
Base Size 7 3/4" x 13 1/2"

8503-I  
Italian Marble  
Base Size 7 3/4" x 16 1/2"

7003-J  
Jet Crystal  
Base Size 8" x 14"

8504-S  
Spanish Onyx  
Base Size 6 1/4" x 10 1/4"

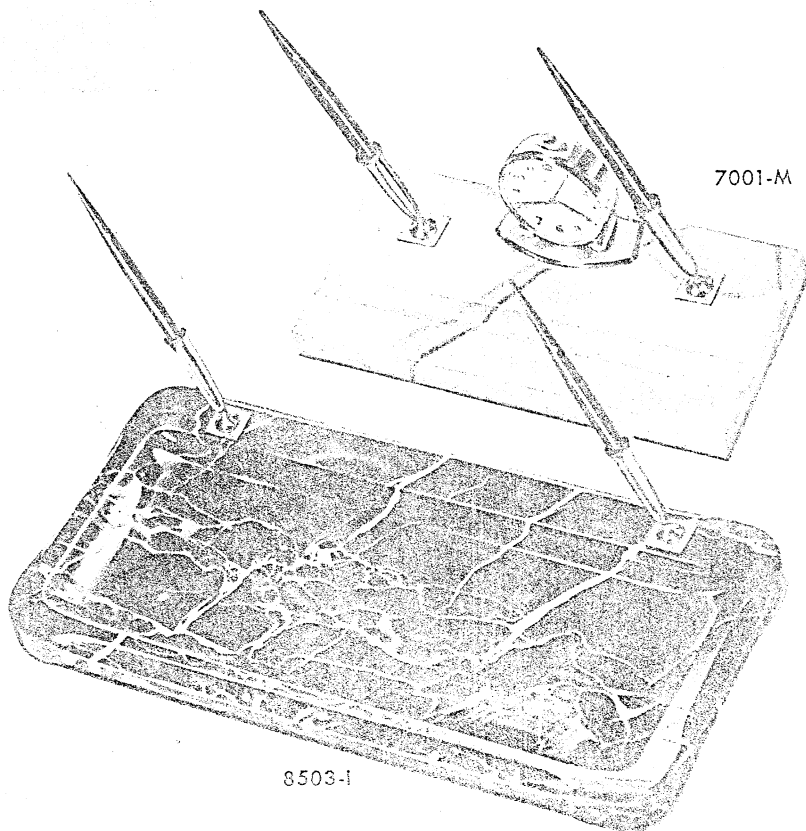

8503-I

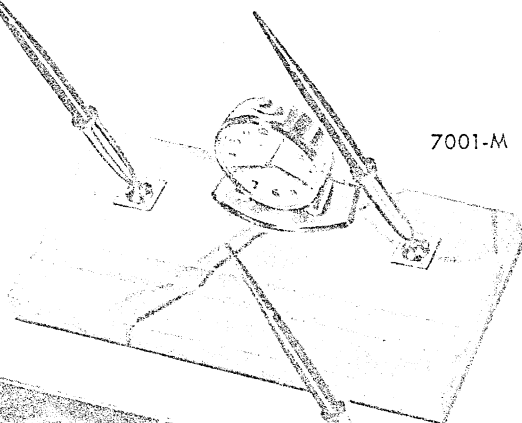

7001-M

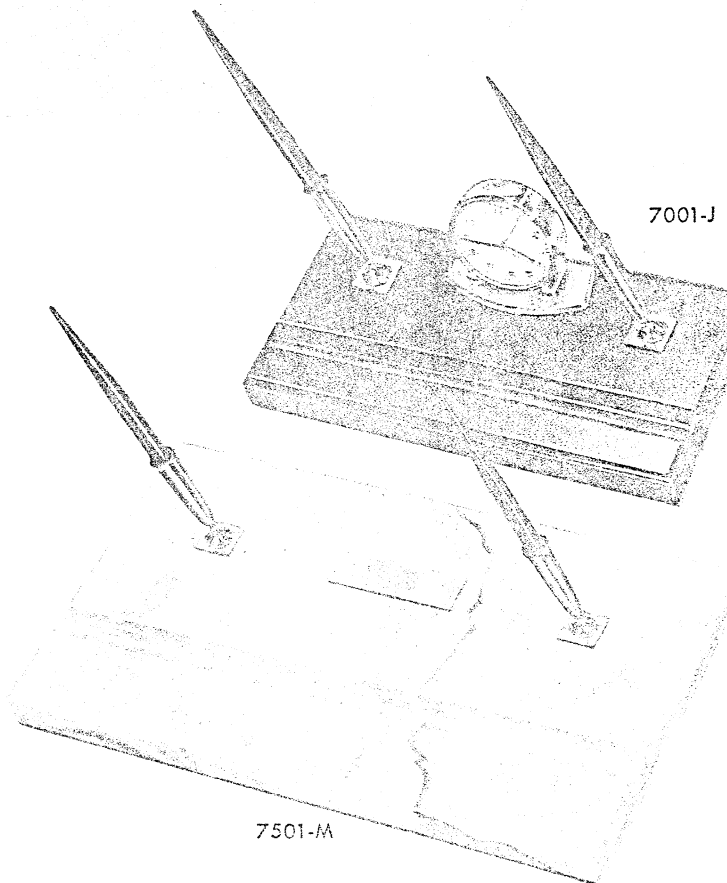

7001-J

7501-M

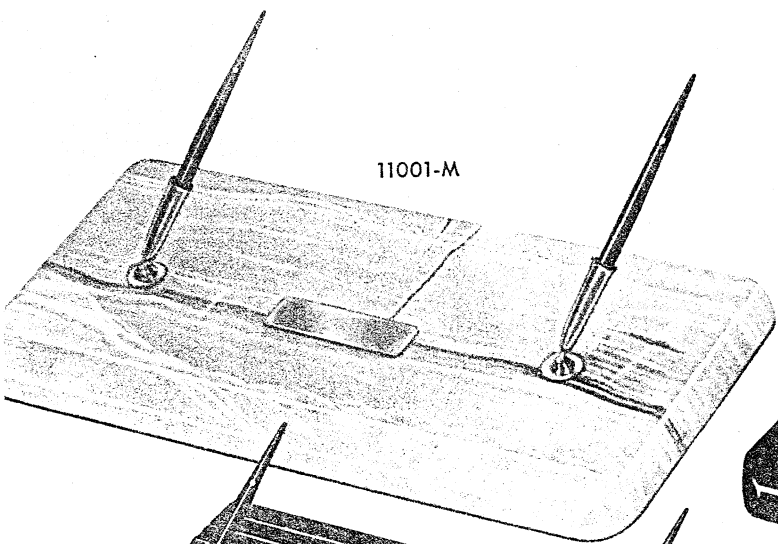

11001-M

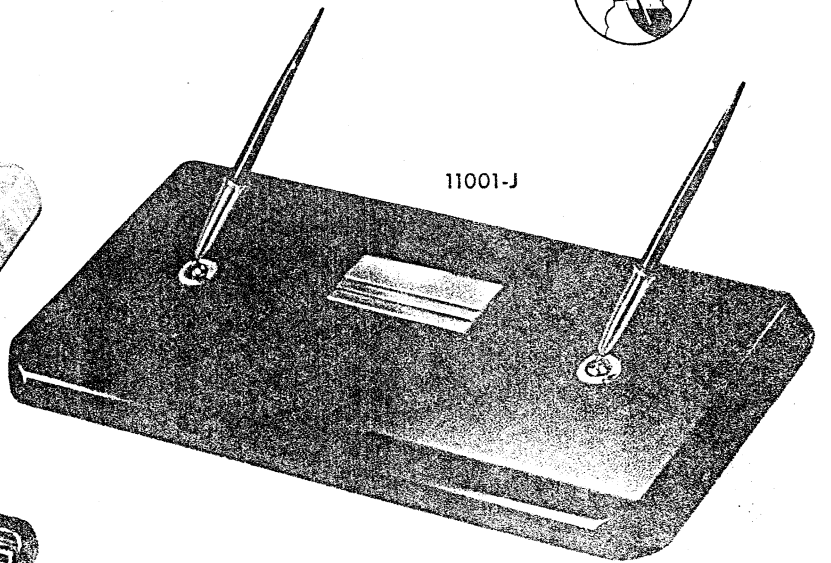

11001-J

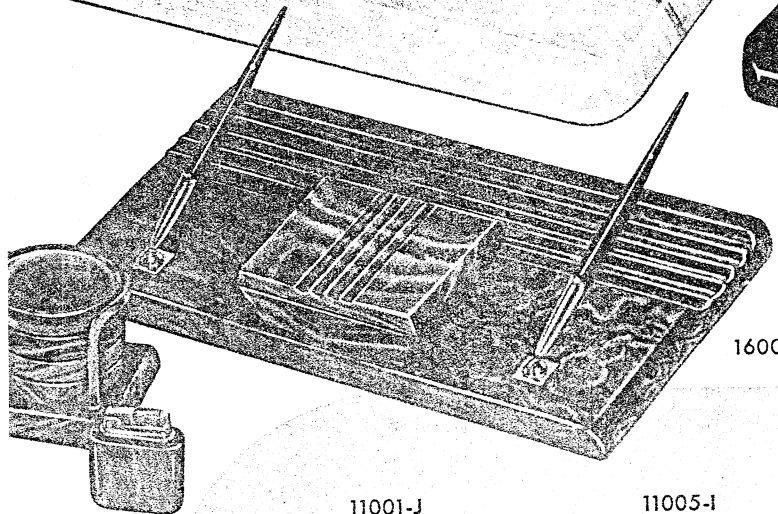

16001-S

11001-J  
Jet Crystal  
Base Size 9" x 19"

11005-I  
Italian Marble  
Base Size 8½" x 16½"

16001-S  
Spanish Onyx  
Base Size 8½" x 16½"

11301-M  
Mexican Onyx  
Base Size 9" x 19"

11004-S  
Spanish Onyx  
Base Size 7¾" x 16½"

11301-J  
Jet Crystal  
Base Size 9" x 19"

11001-M  
Mexican Onyx  
Base Size 9" x 19"

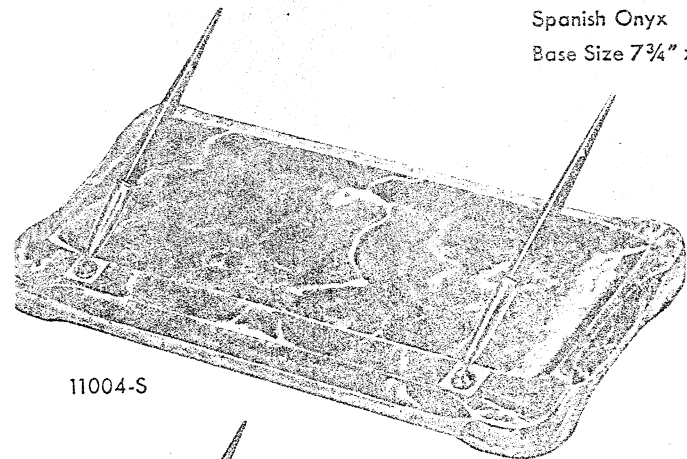

11004-S

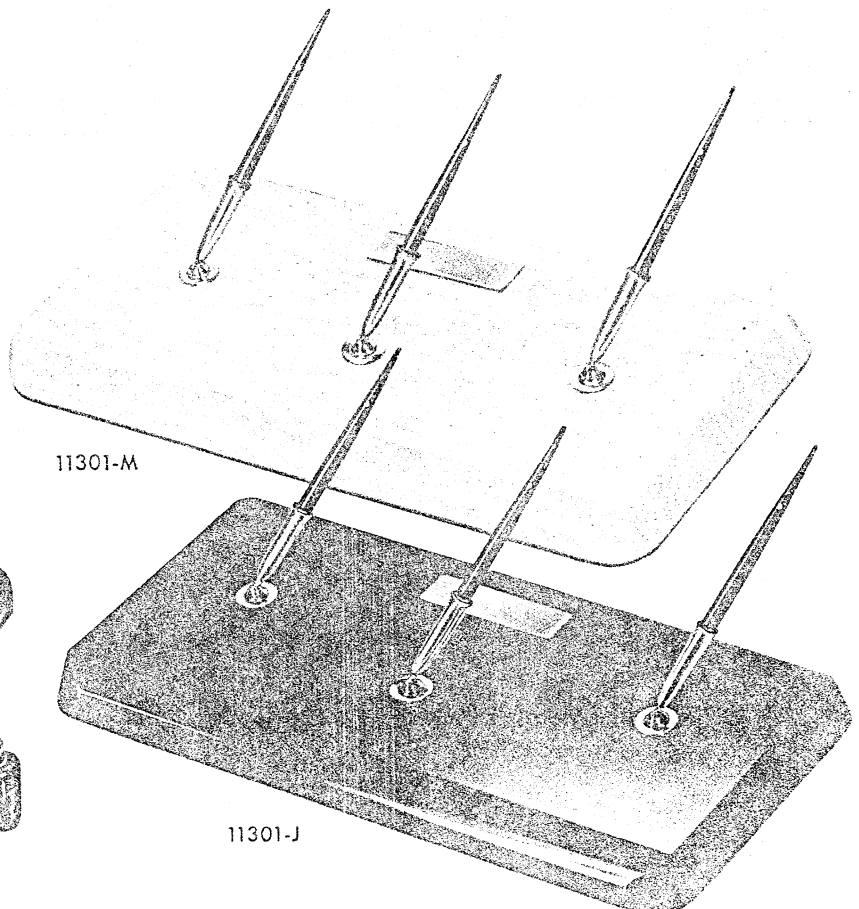

11301-M

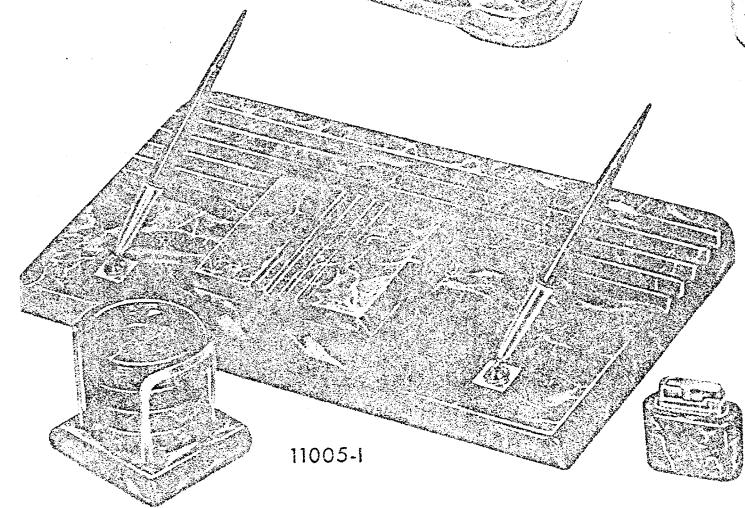

11005-I

11301-J

# Sheaffer's Trophy Desk Sets

with new **SNORKEL** pens

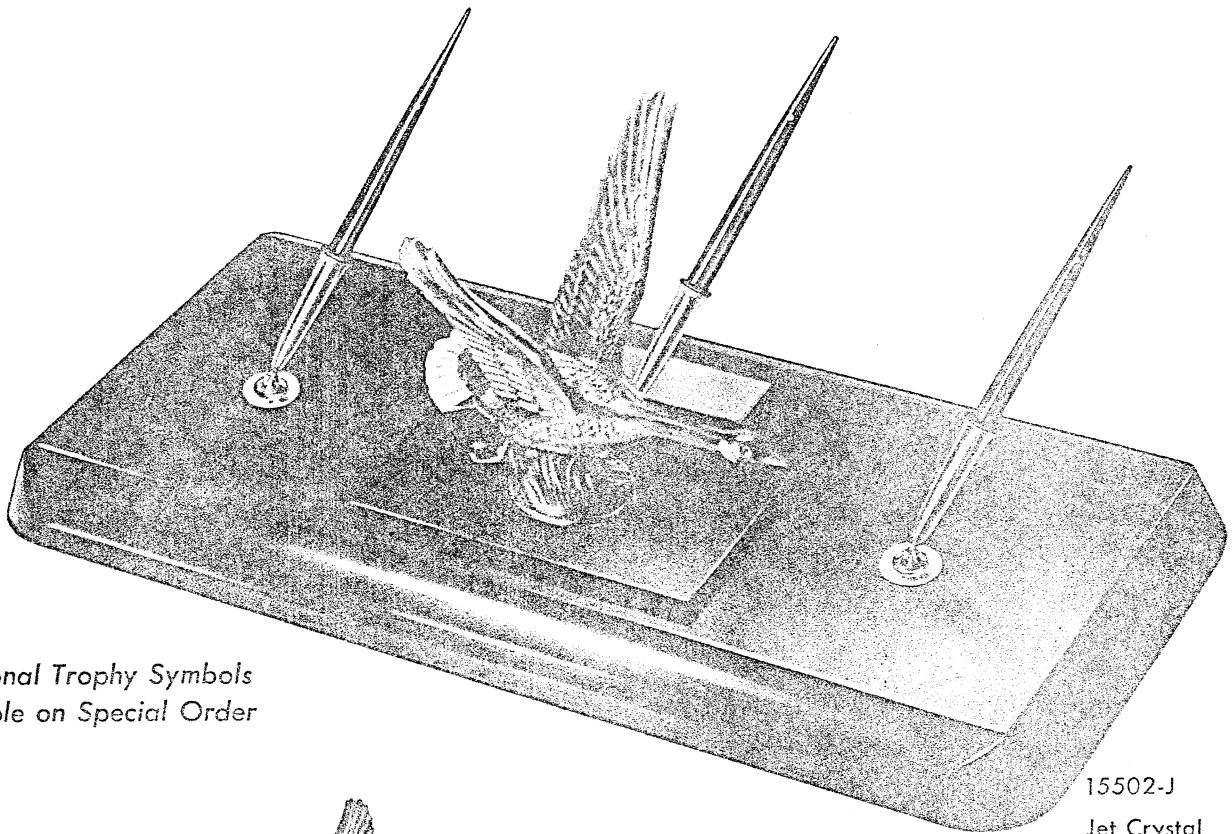

15502-J  
Jet Crystal  
Base size: 9" x 19"

Additional Trophy Symbols  
Available on Special Order

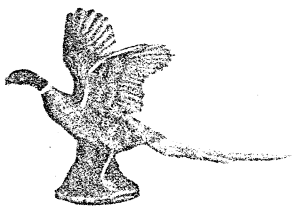

PHEASANT

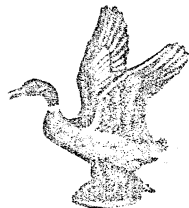

MALLARD



POINTER

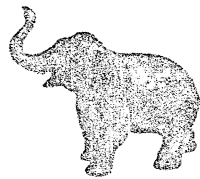

ELEPHANT

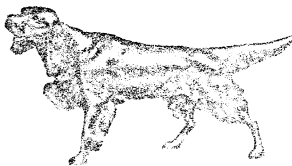

SETTER



GREAT DANE

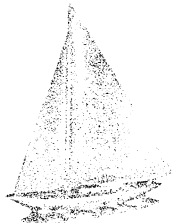

SAILBOAT

Here's living, lasting recognition of accomplishment! To commemorate a special event, to recognize a man's hobby or activity, to reward attainment, nothing else can approach this distinctive desk set. The figure symbolizes the sport, and the engraved nameplate is an imperishable reminder of the proud occasion.

Special Trophy Desk Sets are available for any occasion or can be designed to individual order. Prices on request.



# Sheaffer's

## SAFEGUARD DESK SETS

TIP IT,

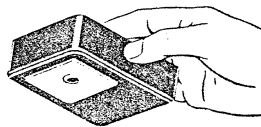

INK WON'T SPILL

DS17

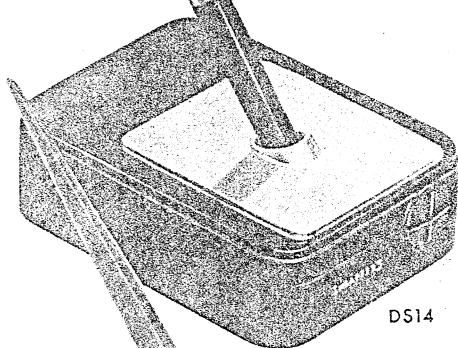
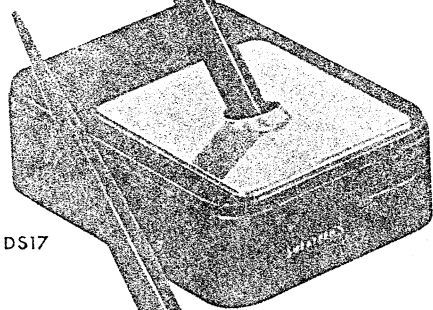

DS14

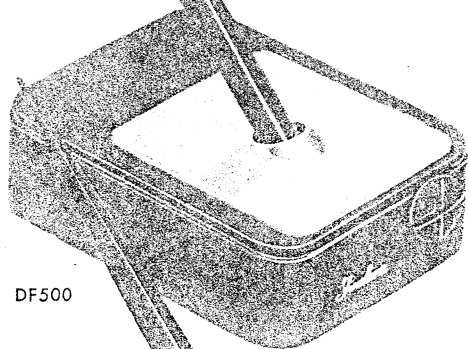

DF500

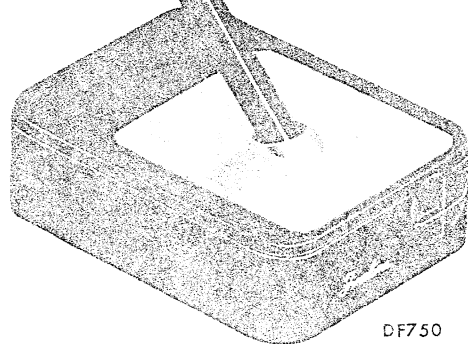

DF750

Convenience of a fountain pen desk set . . . utility of reservoir type. Draws writing fluid automatically, as pen needs it—without clogging, clotting, or corrosion.\* Base holds months and months supply of fluid . . . yet doesn't spill if tipped! Bases available in black, brown, grey, green, and maroon.

*\*Writes pages without redipping*

DS17 Sheaffer White Dot Safeguard Reservoir Desk Set with extra large manifold replaceable 14K gold Sheaffer nib tipped with osmalloy. Available in complete point range including fine, medium, extra fine, Gregg Shorthand. Packed with generous supply of Skrip.

DS14 Sheaffer's Safeguard Reservoir Desk Set with standard 14K gold replaceable Sheaffer nib in choice of fine, medium, extra fine or Gregg Shorthand styles. Complete with generous supply of Skrip.

DF500 Fineline Safeguard Reservoir Desk Set with replaceable stainless steel nib in choice of writing styles—fine, medium, extra fine or Gregg Shorthand. Complete with Skrip refill bottle.

DF750 Fineline Safeguard Reservoir Desk Set with replaceable 14K gold nib in choice of writing styles—fine, medium, extra fine, or Gregg Shorthand. Complete with Skrip refill bottle.

DOUBLE DESK SET . . . Two Safeguard sets mounted in attractive base provide possibilities of using two different colored inks or two different point styles for specialized work. A handsome, useful combination for any desk.

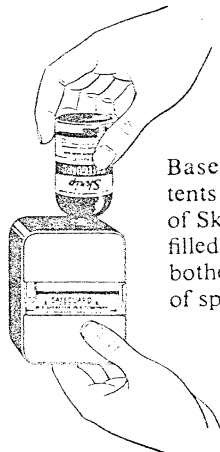
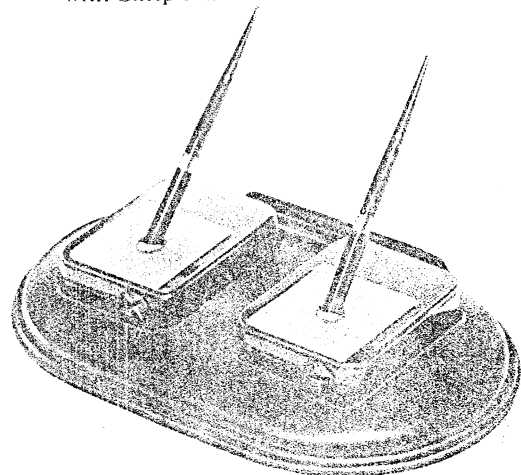

Base holds contents of a full bottle of Skrip, easily refilled without mess, bother, or danger of spilling.



Special Safeguard Skrip bottle is designed to permit filling without spilling. Neck fits securely into opening in base. Top seal is broken only after safe connection is made. No dropper or funnel necessary.



World's Largest Selling Writing Fluid

# SHEAFFER'S Skríp

Makes any pen write better

Used exclusively, Skrip makes every pen—regardless of price class—write better, last longer. Absolutely safe, Skrip won't clot, clog, or corrode—can't injure rubber, metal, or composition parts. Quick-starting, quick-drying, and free-flowing, Skrip eliminates the causes of most common pen faults and failures. Permanent Skrip for business records, Washable Skrip for everyday use—safe for any washable fabric.



**Exclusive TOP WELL BOTTLE**  
Takes the mess out of  
pen filling

PERFECT FOR  
CONVENTIONAL PENS

Top-well keeps a supply of ink at eye level to permit dipping to no deeper depth than necessary.

IDEAL FOR SHEAFFER'S  
new SNORKEL and Tip-Fill Pens

Extending tube of Sheaffer's Snorkel Pen draws its full supply of fluid from the visible Top-Well. Tip-fill pens are immersed to intake opening only.



1-2-4

- 12 beautiful colors
- Washable Persian/ Rose
  - Permanent Jet Black
  - Washable Peacock Blue
  - Permanent Royal Blue
  - Washable Purple
  - Washable Melon Red
  - Washable Brown
  - Washable Blue
  - Washable Black
  - Permanent Blue Black
  - Washable Emerald Green
  - Permanent Red

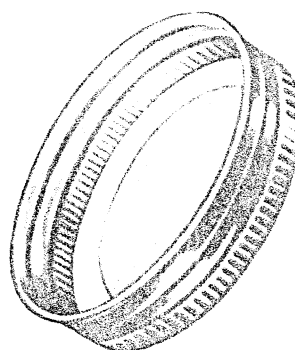

**MAGIC CIRCLE  
DRIP-PROOF CAP**

"Magic-Circle" instantly absorbs excess fluid, leaves bottle rim clean and clear.

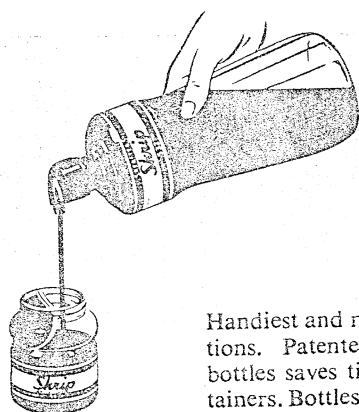

SHEAFFER'S  
Skríp

IN PINTS AND QUARTS

Handiest and most economical size for schools, offices and institutions. Patented, splatter-proof POUR-OUT on pint and quart bottles saves time and eliminates mess in refilling small size containers. Bottles shaped to fit hand—insures added safety in pouring. Also available in gallons.



# Sheaffer's Writing Accessories

## Leads

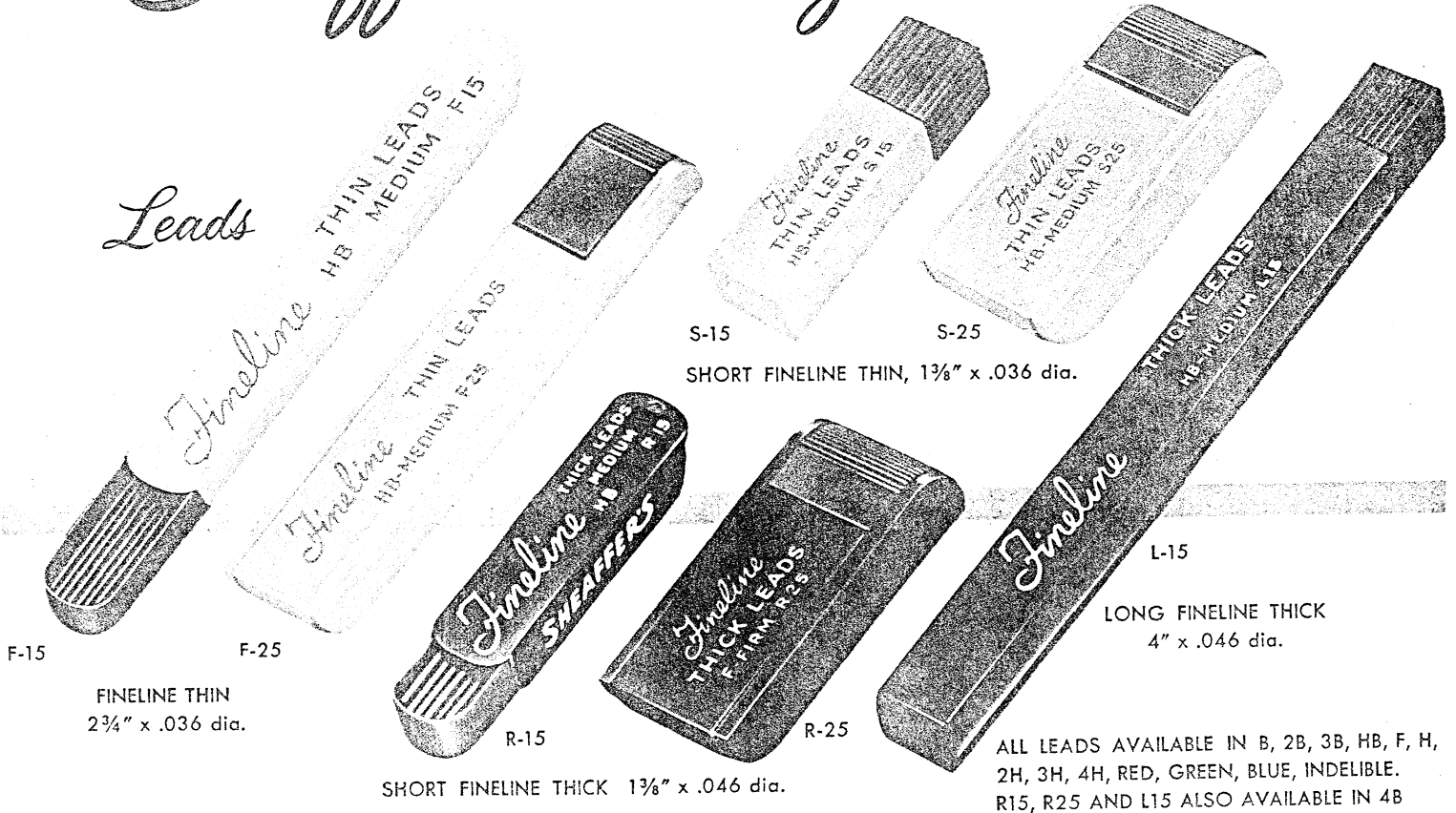

## Erasers

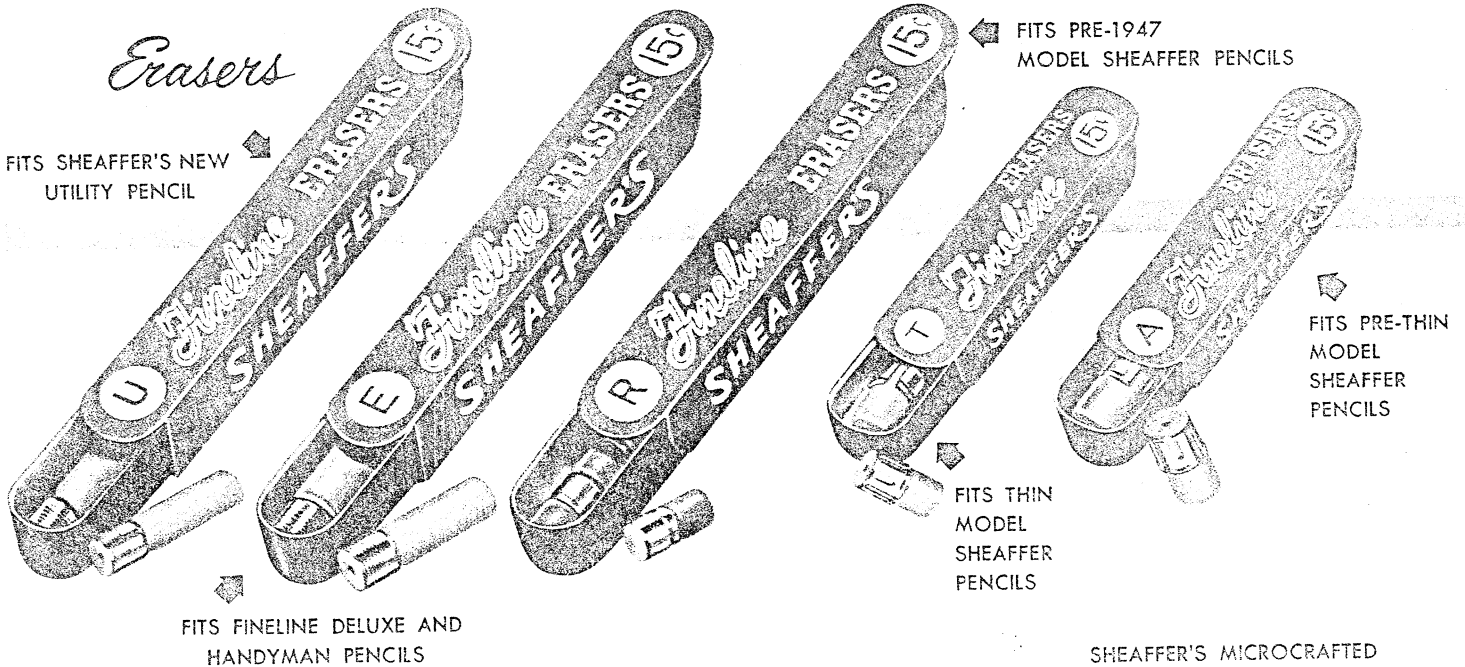

## Ballpoint Units

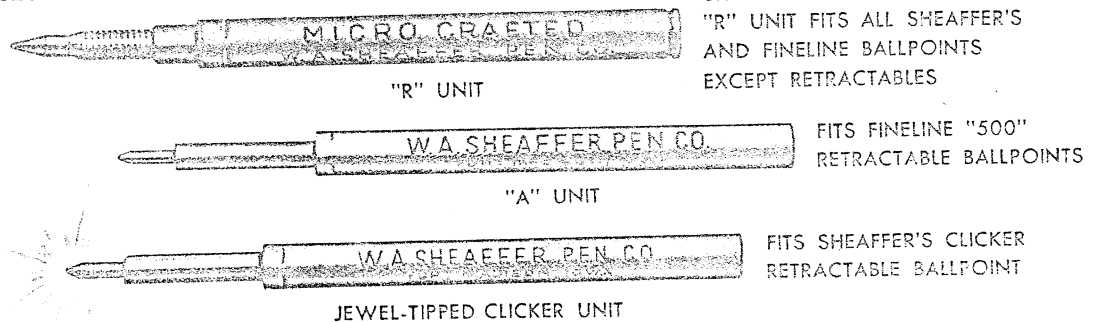

## SHEAFFER'S COMPLETE PRICE LIST

With the exception of clock desk sets, priced as indicated, all prices shown are label prices and include tax. Clocks are labeled to show amount of Federal Excise tax to be added to price of desk set.

PAGE NO.	MODEL	PRICE	ENSEMBLE	THREE-SOME	PAGE NO.	MODEL	PRICE	ENSEMBLE	THREE-SOME
2	Masterpiece Pen..	\$120.00			9	Statesman Pen...	\$12.50		
	Masterpiece Pencil	60.00	\$180.00			Statesman Pencil..	6.00	\$18.50	
3	Autograph Pen...	27.50				Statesman Strato-			
	Autograph Pencil.	17.50	45.00			writer.....	6.00		\$24.50
	Autograph Strato-				10	Sovereign Pen...	12.50		
	writer.....	17.50		\$62.50		Sovereign Pencil..	5.00	17.50	
4	Crest Pen.....	25.00				Sovereign Strato-			
	Crest Pencil.....	9.00	34.00			writer.....	5.00		22.50
	Crest Stratowriter.	9.00		43.00	11	Saratoga Pen...	10.00		
5	Signature Pen....	22.50				Saratoga Pencil..	5.00	15.00	
	Signature Pencil..	10.00	32.50			Saratoga Strato-			
	Signature Strato-					writer.....	5.00		20.00
	writer.....	10.00		42.50		Admiral Pen.....	7.50		
6	Sentinel Pen.....	20.00				Admiral Pencil...	5.00	12.50	
	Sentinel Pencil...	7.50	27.50			Admiral Strato-			
	Sentinel Strato-					writer.....	5.00		17.50
	writer.....	7.50		35.00	12	Craftsman Pen...	5.00		
7	Valiant Pen.....	17.50				Craftsman Pencil..	4.00	9.00	
	Valiant Pencil....	6.00	23.50		13	Cadet Pen.....	3.75		
	Valiant Strato-					Cadet Pencil.....	3.00	6.75	
	writer.....	6.00		29.50					
8	Clipper Pen.....	15.00							
	Clipper Pencil....	7.50	22.50						
	Clipper Strato-								
	writer.....	7.50		30.00					

### SHEAFFER'S DESK SET SECTION

All prices include White Dot Snorkel Pen. For substitution of each conventional point Snorkel Desk pen, desk pencil or desk stratowriter in place of a White Dot Snorkel desk pen, deduct \$7.50 from label price.

**CODE:**

121SKD—Black "White Dot" Snorkel Desk Pen  
 B121SKD—Brown "White Dot" Snorkel Desk Pen  
 5SKD—Black Conventional point Snorkel Desk Pen  
 B5SKD—Brown Conventional point Snorkel Desk Pen

LD4—Black desk pencil  
 BD4—Brown desk pencil  
 RL4TD—Black Stratowriter ballpoint  
 RB4TD—Brown Stratowriter ballpoint

PAGE NO.	MODEL	PRICE	PAGE NO.	MODEL	PRICE
18	2001-M With B121SKD pen.....	\$20.00	18	2501-M With B121SKD pen.....	\$25.00
18	2001-I With 121SKD pen.....	20.00	19	2503-S With B121SKD pen.....	25.00
18	2001-B With 121SKD pen.....	20.00	19	2504-I With 121SKD pen.....	25.00
18	2003-S With B121SKD pen.....	20.00	19	2505-G With 121SKD pen.....	25.00
18	2201-B With 121SKD pen.....	22.50	19	2506-J With 121SKD pen.....	25.00
18	2202-M With B121SKD pen.....	22.50	19	2701-J With 121SKD pen.....	27.50
18	2202-S With B121SKD pen.....	22.50	19	2702-J With 121SKD pen.....	27.50
18	2203-M With B121SKD pen.....	22.50	19	2703-M With B121SKD pen.....	27.50
18	2203-S With B121SKD pen.....	22.50	19	2704-S With B121SKD pen.....	27.50
18	2204-I With 121SKD pen.....	22.50	19	2704-M With B121SKD pen.....	27.50
18	2205-G With 121SKD pen.....	22.50	19	2705-G With 121SKD pen.....	27.50
18	2206-B With 121SKD pen with Chain	22.50	20	3001-J With 121SKD pen.....	30.00
18	2501-J With 121SKD pen.....	25.00	20	3001-M With B121SKD pen.....	30.00



PAGE NO.	MODEL	PRICE
20	3002-J With 121SKD pen and Calendar.....	\$30.00
20	3002-M With B121SKD pen and Calendar.....	30.00
20	3003-S With B121SKD pen.....	30.00
20	3004-G With 121SKD pen.....	30.00
20	4201-I With 121SKD pen.....	42.50
20	4501-J With 2 121SKD pens.....	45.00
21	4501-M With 2 B121SKD pens....	45.00
21	4502-I With 2 121SKD pens.....	45.00
21	4503-J With 121SKD Pen and No. 583 Clock.....	45.00
21	4503-M With B121SKD Pen and No. 583 Clock.....	45.00
21	5001-J With 2 121SKD pens.....	50.00
21	5001-M With 2 B121SKD pens....	50.00
21	5002-J With 2 121SKD pens.....	50.00
21	5003-J With 2 121SKD pens and Chain Attachments.....	50.00
22	5004-J With 2 121SKD pens.....	50.00
22	5201-S With B121SKD pen.....	52.50
22	5301-J With 121SKD pen, LD4 pencil, RL4TD Stratowriter.....	53.00
22	5501-J With 2 121SKD pens and Calendar.....	55.00
22	5502-J With 2 121SKD pens.....	55.00
22	5503-S With 2 B121SKD pens....	55.00
22	6001-S With 2 B121SKD pens....	60.00

PAGE NO.	MODEL	PRICE
22	6002-I With 2 121SKD pens.....	\$60.00
23	7001-J With 2 121SKD pens and No. 583 Clock.....	70.00
23	7001-M With 2 B121SKD pens and No. 583 Clock.....	70.00
23	7002-S With 2 B121SKD pens....	70.00
23	7003-J With 2 121SKD pens.....	70.00
23	7501-M With 2 B121SKD pens....	75.00
23	8501-J With 2 121SKD pens and No. 583 Clock.....	85.00
23	8503-I With 2 121SKD pens.....	85.00
23	8504-S With 2 B121SKD pens and No. 583 Clock.....	85.00
24	11001-M With 2 B121SKD pens..	110.00
24	11001-J With 2 121SKD pens....	110.00
24	11004-S With 2 B121SKD pens....	110.00
24	11005-I With 2 121SKD Pens and Cigarette Box, Nested Tray, and Lighter.....	110.00
24	11301-J With 121SKD Pen, LD4 Pencil and RL4TD Stratowriter..	113.00
24	11301-M With B121SKD Pen, BD4 Pencil and RB4TD Stratowriter..	113.00
24	16001-S With 2 B121SKD Pens and Cigarette Box, Nested Tray, and Lighter.....	160.00
25	15502-J With 121SKD Pen, RL4TD Stratowriter and LD4 Pencil & Trophy.....	155.00

### SHEAFFER'S SAFEGUARDS

26	Safeguard DF500.....	\$ 5.00	26	Safeguard DS17.....	\$12.50
26	Safeguard DF750.....	7.50	26	Chain attachments available on all sets for	1.00
26	Safeguard DS14.....	10.00			

### SHEAFFER'S WRITING ACCESSORIES

27	Leads, F-15, S-15, R-15, L-15. \$0.15 per tube	27	Refill unit, R.....	\$0.50
27	F-25, S-25, R-25..... .25 per tube	27	Refill unit, A.....	.50
27	Erasers—T, A, E, U, R..... .15 per tube	27	Refill unit, Clicker.....	1.00

### SHEAFFER'S SKRIP

28	Skip, 2 oz.....\$0.15 per bottle	28	Skip, quart.....	\$1.50 per bottle
28	Skip, 4 oz..... .25 per bottle	28	Skip, gallon.....	5.00 per bottle
28	Skip, pint..... .90 per bottle			

**W. A. SHEAFFER PEN COMPANY**  
FORT MADISON, IOWA

# SHEAFFER'S FEATHER-TOUCH POINT SELECTION CHART

## Sixteen 14K Gold Points to choose from

The smoothest-writing point, in the pen point metal that lasts forever! Sheaffer's big, cylindrical 14K gold point is precision-ground to fit your exact style of writing. Instant-starting, smooth-gliding, as carefully crafted

as you'd expect only Sheaffer to be! Choose from 16 personalized points. No break-in—writes the way you want—right from the start. Special grinds other than those shown below available on individual order.

### A POINT FOR EVERY WRITING STYLE

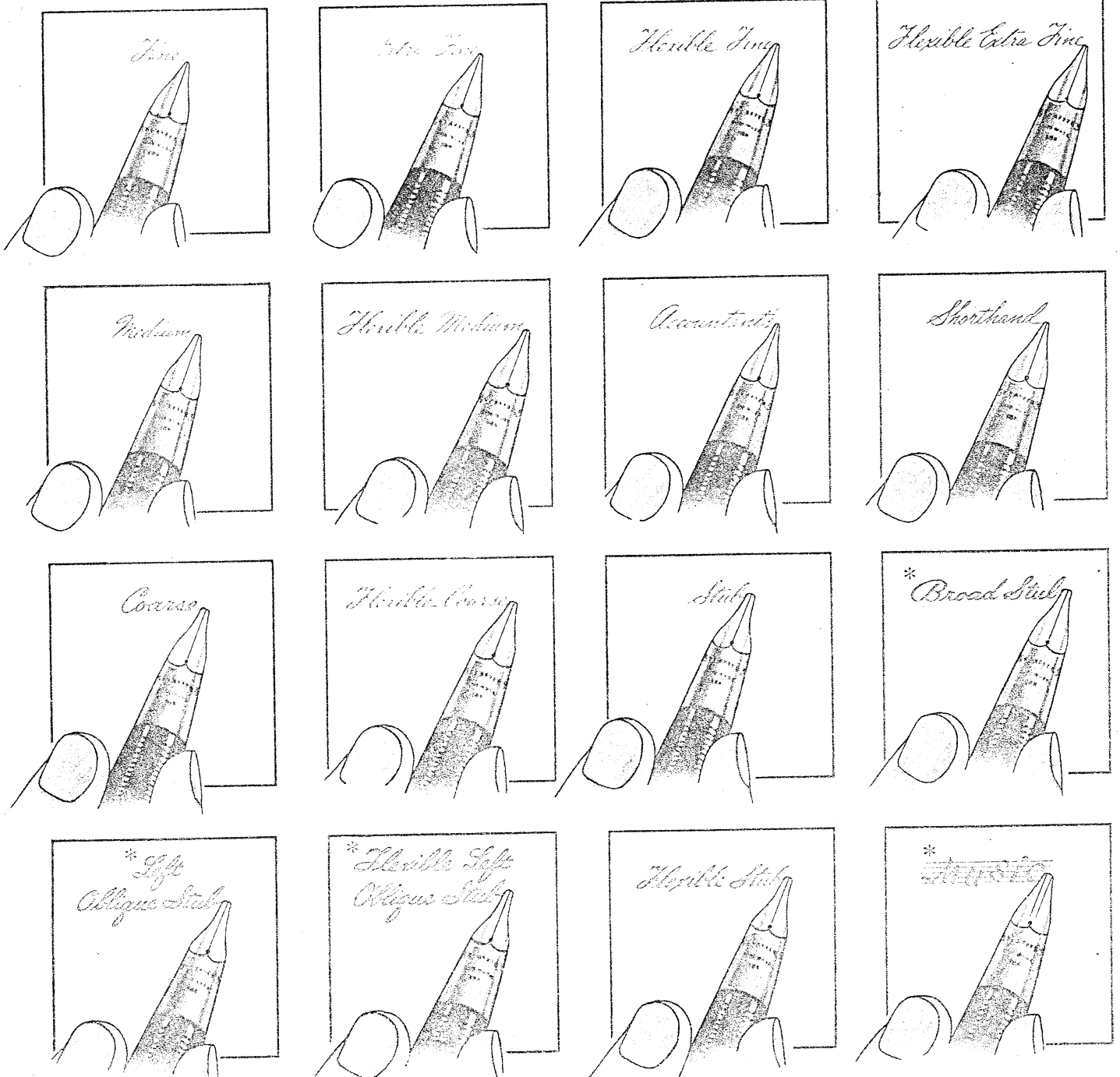

\*Available at Slight Extra Charge

# SHEAFFER'S

WHITE DOT, A QUALITY OF DISTINCTION

W. A. SHEAFFER PEN COMPANY

100 MADISON AVENUE, NEW YORK

IN CANADA: GORRENTZ & CO. LTD.

IN GREAT BRITAIN: LONDON

IN AUSTRALIA: MELBOURNE